



INSTRUCTION MANUAL

VHF TRANSCEIVER
IC-V82
UHF TRANSCEIVER
IC-U82

This device complies with Part 15 of the FCC rules. Operation is subject to the following two conditions: (1) This device may not cause harmful interference, and (2) this device must accept any interference received, including interference that may cause undesired operation.

Icom Inc.



IC-V82

IC-U82

FOREWORD

Thank you for purchasing this Icom product. The IC-V82/U82 VHF/UHF TRANSCEIVERS are designed and built with Icom's superior technology and craftsmanship. With proper care, this product should provide you with years of trouble-free operation.

We want to take a couple of moments of your time to thank you for making your IC-V82/U82 your radio of choice, and hope you agree with Icom's philosophy of "technology first." Many hours of research and development went into the design of your IC-V82/U82.

◆ FEATURES

- 7 W*— *high transmit output power*
(*IC-V82, 5 W for IC-U82)
- *CTCSS and DTCS encoder/decoder standard*
- *Optional digital modulator/demodulator*
- *Optional DTMF decoder*

IMPORTANT

READ ALL INSTRUCTIONS carefully and completely before using the transceiver.

SAVE THIS INSTRUCTION MANUAL— This instruction manual contains important operating instructions for the IC-V82/U82.

EXPLICIT DEFINITIONS

WORD	DEFINITION
⚠ WARNING!	Personal injury, fire hazard or electric shock may occur.
CAUTION	Equipment damage may occur.
NOTE	Recommended for optimum use. No risk of personal injury, fire or electric shock.

Icom, Icom Inc. and the ICOM logo are registered trademarks of Icom Incorporated (Japan) in the United States, the United Kingdom, Germany, France, Spain, Russia and/or other countries.

PRECAUTIONS

⚠ WARNING! NEVER hold the transceiver so that the antenna is very close to, or touching exposed parts of the body, especially the face or eyes, while transmitting. The transceiver will perform best if the microphone is 5 to 10 cm (2 to 4 inches) away from the lips and the transceiver is vertical.

⚠ WARNING! NEVER operate the transceiver with a headset or other audio accessories at high volume levels. Hearing experts advise against continuous high volume operation. If you experience a ringing in your ears, reduce the volume or discontinue use.

NEVER connect the transceiver to a power source that is DC fused at more than 5 A. Accidental reverse connection will be protected by this fuse, but higher fuse values will not give any protection against such accidents and the transceiver will be ruined.

NEVER attempt to charge alkaline or dry cell batteries. Be aware that external DC power connections will charge batteries inside the battery case. This will damage not only the battery case but also the transceiver.

DO NOT push the PTT when not actually desiring to transmit.

Place the unit in a secure place to avoid inadvertent use by children.

DO NOT operate the transceiver near unshielded electrical blasting caps or in an explosive atmosphere.

AVOID using or placing the transceiver in direct sunlight or in areas with temperatures below -10°C ($+14^{\circ}\text{F}$) or above $+60^{\circ}\text{C}$ ($+140^{\circ}\text{F}$).

The use of non-Icom battery packs/chargers may impair transceiver performance and invalidate the warranty.

Even when the transceiver power is OFF, a slight current still flows in the circuits. Remove the battery pack or case from the transceiver when not using it for a long time. Otherwise, the battery pack or installed rechargeable batteries (Ni-Cd: BP-222N, BP-209N, Ni-MH: BP-210N, Li-Ion: BP-211N) will become exhausted.

For USA only:

Caution: Changes or modifications to this transceiver, not expressly approved by Icom Inc., could void your authority to operate this transceiver under FCC regulations.

SUPPLIED ACCESSORIES

■ Supplied Accessories

- ① Antenna* 1
- ② Belt clip (with screws) 1
- ③ AC Adapter* 1
- ④ Battery pack*/Battery case* 1
- ⑤ Battery charger* 1 set

*Not supplied with some versions.

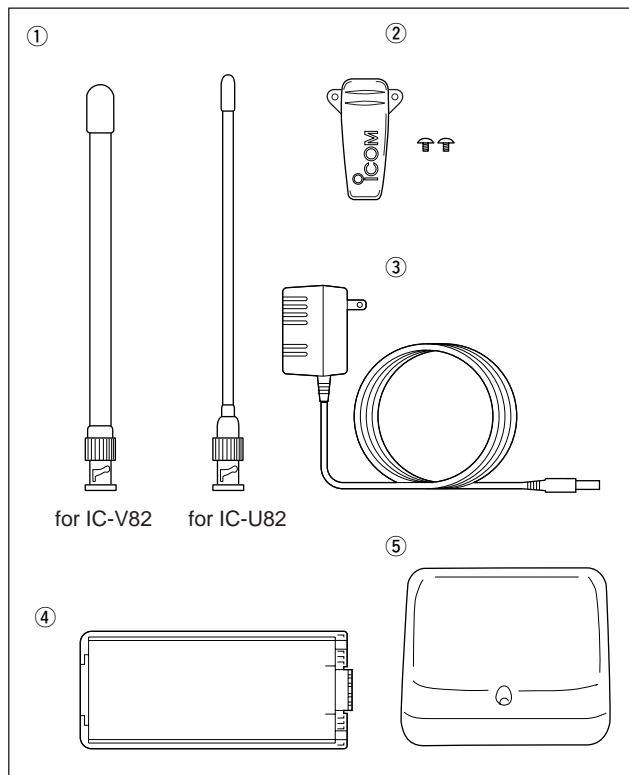

SAFETY TRAINING INFORMATION

CAUTION

To ensure that your exposure to RF electromagnetic energy is within the FCC allowable limits, always adhere to the following guidelines:

- **DO NOT** operate the radio without a proper antenna attached, as this may damage the radio and may also cause you to exceed FCC RF exposure limits. A proper antenna is the antenna supplied with this radio by the manufacturer or an antenna specifically authorized by the manufacturer for use with this radio.
- **DO NOT** transmit for more than 50% of total radio use time (“50% duty cycle”). Transmitting more than 50% of the time can cause FCC RF exposure compliance requirements to be exceeded. The radio is transmitting when the “Tx indicator” appears. You can cause the radio to transmit by pressing the “PTT” switch.
- **ALWAYS use** Icom authorized accessories (antennas, batteries, belt clips, speaker/mics, etc.). Use of unauthorized accessories can cause the FCC RF exposure compliance requirements to be exceeded.

- **ALWAYS keep** the antenna at least 2.5 cm (1 inch) away from the body when transmitting, and only use the Icom belt-clips which are listed in this manual when attaching the radio to your belt, etc. To provide the recipients of your transmission the best sound quality, hold the transceiver at least 5 cm (2 inches) from your mouth, and turned slightly to one side.

The information listed above provides the user with the information needed to make him or her aware of RF exposure, and what to do to assure that this radio operates within the FCC RF exposure limits of this radio.

Electromagnetic Interference/Compatibility

During transmissions, your Icom radio generates RF energy that can possibly cause interference with other devices or systems. To avoid such interference, turn off the radio in areas where signs are posted to do so. **DO NOT** operate the transmitter in areas that are sensitive to electromagnetic radiation such as hospitals, aircraft, and blasting sites.

TABLE OF CONTENTS

FOREWORD	i
IMPORTANT	i
EXPLICIT DEFINITIONS	i
PRECAUTIONS	ii
SUPPLIED ACCESSORIES	iii
SAFETY TRAINING INFORMATION	iv
TABLE OF CONTENTS	v–vi

QUICK REFERENCE GUIDE I–V

■ Preparation	I
■ Your first contact	III
■ Repeater operation	IV
■ Programming memory channels	V

1 ACCESSORIES..... 1–2

■ Accessory attachment	1
------------------------------	---

2 PANEL DESCRIPTION 3–7

■ Switches, controls, keys and connectors	3
■ Function display	6

3 BATTERY PACKS 8–12

■ Battery pack replacement	8
■ Battery caution	9
■ Charging NOTE	9
■ Battery charging	10
■ Battery case (optional for some versions)	12

4 BASIC OPERATION..... 13–16

■ Power ON	13
■ VFO mode selection	13

■ Setting a frequency	13
■ Setting audio/squelch level	15
■ Receive and transmit	15
■ Display type	16
■ Key lock function	16

5 REPEATER OPERATION 17–20

■ General	17
■ Reversed duplex mode	17
■ Offset frequency	18
■ Subaudible tones	18
■ Repeater lockout	19
■ Auto repeater function (USA/CSA versions only)	20

6 MEMORY/CALL OPERATION 21–26

■ General description	21
■ Selecting a memory channel	21
■ Selecting the call channel	21
■ Programming the memory/call channels	22
■ Channel name programming	23
■ Memory transfers	23
■ Memory bank selection	25
■ Memory bank setting	25
■ Transferring bank contents	26

7 DTMF MEMORY 27–29

■ Programming a DTMF code sequence	27
■ Transmitting a DTMF code sequence	28
■ DTMF transmission rate	29

8 SCAN OPERATION.....	30–33		
■ Scan types	30	■ Low-speed data communication	50
■ Programmed scan	30	■ About D-STAR system	51
■ Memory scan.....	31	■ Repeater call sign programming	52
■ Skip channels.....	32	■ Setting other items	53
■ Priority watch.....	32	■ GPS operation	57
■ Scan resume condition.....	33	12 OTHER FUNCTIONS	59–70
9 SUBAUDIBLE TONES	34–37	■ SET MODE.....	59
■ Tone squelch	34	■ INITIAL SET MODE	63
■ Pocket beep operation	36	■ Weather channel operation	
■ Tone scan.....	37	(IC-V82 [USA]/[CSA] versions only).....	69
10 PAGER/CODE SQUELCH (Requires Optional UT-108) ..	38–41	■ CPU reset.....	70
■ Pager function	38	■ Partial reset.....	70
■ Code programming	38	13 CLONING	71–72
■ Pager operation.....	40	■ Transceiver-to-transceiver cloning	71
■ Code squelch	41	■ Cloning using a PC	72
11 DIGITAL MODE OPERATION		14 OPTIONAL UNITS.....	73–74
(Requires Optional UT-118).....	42–58	■ Optional UT-108/118 installation	73
■ Digital mode operation	42	■ Optional MB-86 installation	73
■ Call sign programming	42	15 SPECIFICATIONS	75–76
■ Digital voice mode operation	45	■ IC-V82	75
■ When receiving a digital call	46	■ IC-U82.....	76
■ Break-in communication	47	16 OPTIONS.....	77–78
■ EMR communication	48	17 MODE ARRANGEMENT	79–81
■ Pocket beep operation	48	18 CE.....	82–83
■ Digital squelch functions	49		
■ Digital monitor	49		

1
2
3
4
5
6
7
8
9
10
11
12
13
14
15
16
17
18

QUICK REFERENCE GUIDE

■ Preparation

◇ Battery pack replacement

Before replacing the battery pack, push and hold **[PWR]** for 1 sec. to turn the power OFF.

- Slide the battery release forward, then pull the battery pack upward with the transceiver facing away from you.

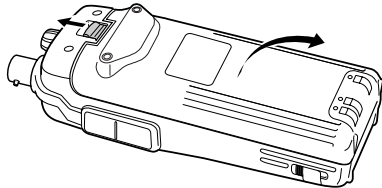

◇ Battery case— optional for some versions

When using a BP-208N BATTERY CASE attached to the transceiver, install 6 AA (LR6) size alkaline batteries as illustrated below.

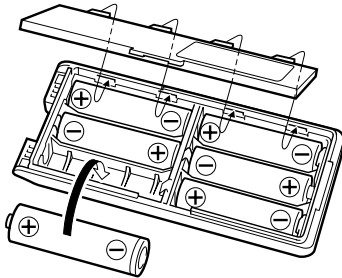

◇ Charging with the BC-144N/146

The optional BC-144N provides rapid charging, and the BC-146 provides regular charging of an optional battery pack with or without a transceiver attached. The following is additionally required:

- An optional AC adapter. (An AD-99N is supplied with BC-144N or BC-146.)

Turn power OFF.

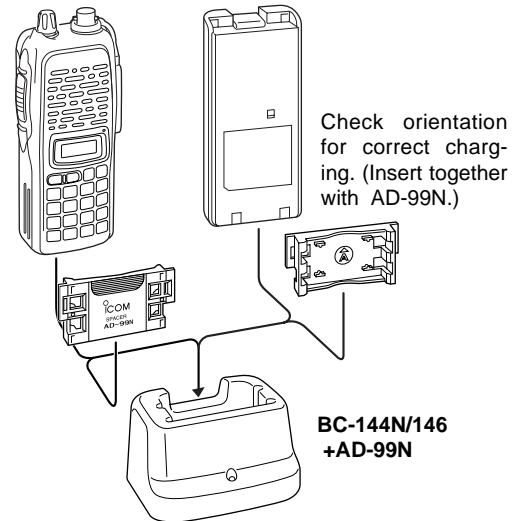

◇ **About AD-99N**

The adapter (Spacer A) only is required for the IC-V82/U82 series. When removing the spacer (Spacer B/C), push the latch carefully with your finger to remove the spacer (Spacer B/C) from the adapter (Spacer A).

Remove the spacer (Spacer B/C) from the adapter.

Push the latch carefully.

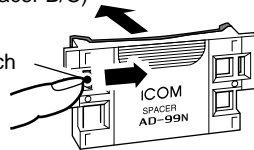

⚠ **CAUTION!**

- **DO NOT** push or force the latch with a screw driver, etc., to remove it.
- **DO NOT** bend the latch when the adapter and spacer are not joined together. This will cause weakening of the latch plastic.
- Both cases may break the latch and it may not be able to be reattached.

◇ **Antenna**

Attach the antenna to the transceiver as illustrated at right.

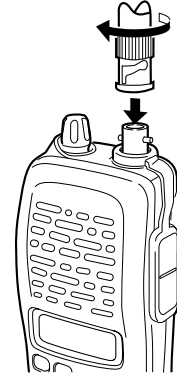

◇ **Belt clip**

Conveniently attaches to your belt.

Attach the belt clip with the supplied screws using a phillips screwdriver.

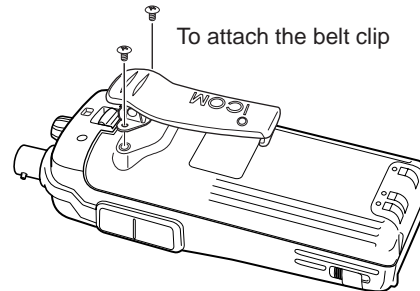

QUICK REFERENCE GUIDE

■ Your first contact

Now that you have your IC-V82/U82 ready, you are excited to get on the air. We would like to walk you through a few basic operational steps to make your first “On The Air” use an enjoyable experience.

◇ About default setting

The [VOL] control function can be exchanged with [▲]/[▼] keys function in INITIAL SET MODE. However, in this QUICK REFERENCE, the factory default setting ([VOL] controls audio output level) is used to simplify instructions.

◇ Basic operation

1. Turning ON the transceiver

Although you have purchased a brand new transceiver, some settings may be changed from the factory defaults because of the Quality Control process. Resetting the CPU is necessary to start from factory default.

- While pushing [MONI] and [D•CLR], push and hold [PWR] for 1 sec. to reset the CPU and turn power ON.

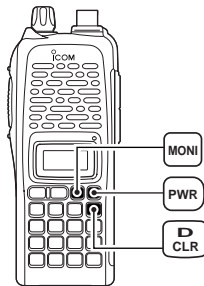

2. Adjusting audio output level

- Rotate [VOL] to set the desired audio level.

3. Adjusting the squelch level

- While pushing and holding [MONI], push [▲] or [▼] to set the squelch level.

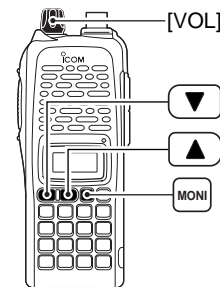

4. Tune the desired frequency

The up/down keys, [▲]/[▼], will allow you to tune to the frequency that you want to operate on. Page 14 will instruct you on how to adjust the tuning step size.

- Push [▲] or [▼] to adjust the frequency.

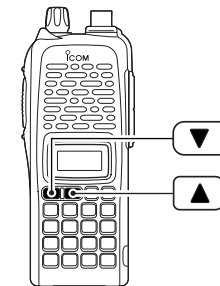

Direct frequency input from the keypad is also available.

- ➔ To enter the desired frequency, enter 6 digits starting from the 100 MHz digit.
 - Entering three* to five digits then pushing [***ENT**] will also set the frequency. (*Some versions only requires two digits.)
 - When a digit is mistakenly input, push [**D.CLR**] to abort input.

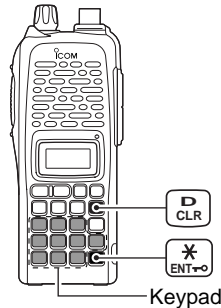

• **Example 1— when entering 145.525 MHz**

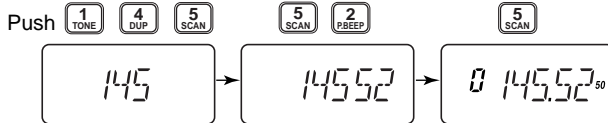

• **Example 2— when entering 144.800 MHz**

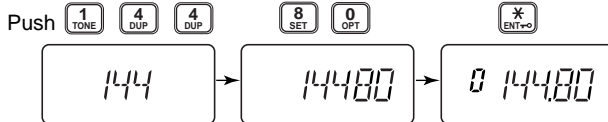

5. Transmit and receive

- ➔ Push and hold [**PTT**] to transmit, then speak into the microphone; release to receive.

■ Repeater operation

1. Setting duplex

- ➔ Push [**A•FUNC**], then [**4•DUP**] several times to select minus duplex or plus duplex.
 - The USA/CSA versions have an auto repeater function, therefore, setting duplex is not required.

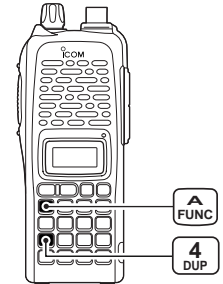
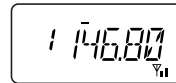

2. Repeater tone

- ➔ Push [**A•FUNC**], then [**1•TONE**] several times until "♪" appears, if required.

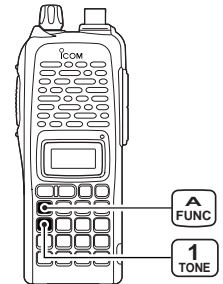
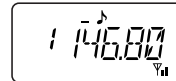

■ Programming memory channels

The IC-V82/U82 has a total of 207 memory channels (including 6 scan edges and 1 call channel) for storing often used operating frequency, repeater settings, etc.

1. Setting frequency

In VFO mode, set the desired operating frequency with other desired settings, such as repeater and subaudible tone.

2. Selecting a memory channel

➔ Push [A•FUNC] and [C•MR] then push [▲] or [▼] several times to select the desired memory channel.

- “MR” indicator and memory channel number blink.

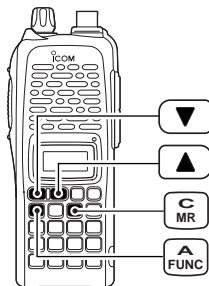
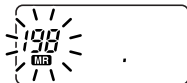

3. Writing a memory channel

- ➔ Push [A•FUNC], then push and hold [C•MR] for 1 sec. to program.
 - 3 beeps sound.

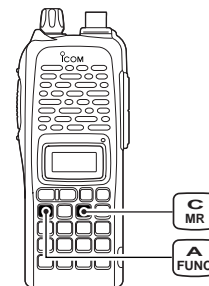
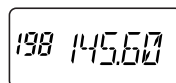

- Continue to push and hold [C•MR] for 1 sec. after 3 beeps are emitted, to increment the displayed memory channel number.

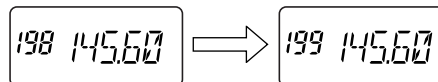

■ Accessory attachment

◇ Antenna

Attach the antenna to the transceiver as illustrated below.

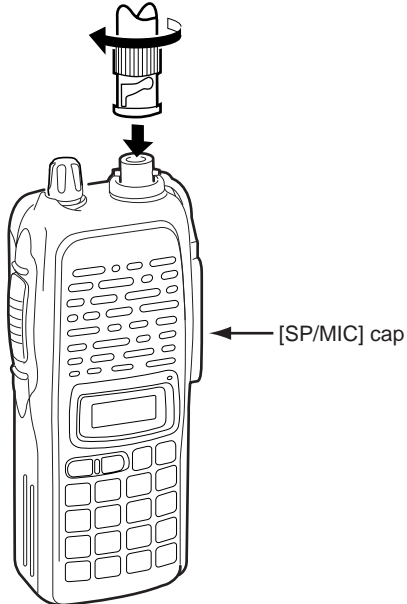

Keep the [SP/MIC] cap (SP/MIC jack cover) attached when jacks are not in use to keep the contacts clean.

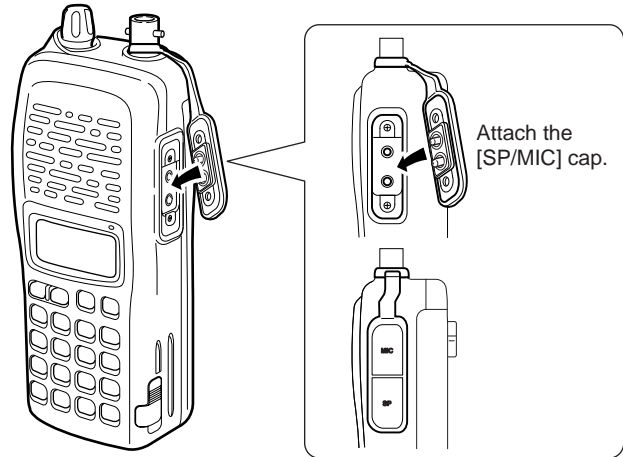

1 ACCESSORIES

◇ Belt clip

Conveniently attaches to your belt.
Attach the belt clip with the supplied screws using a phillips screwdriver.

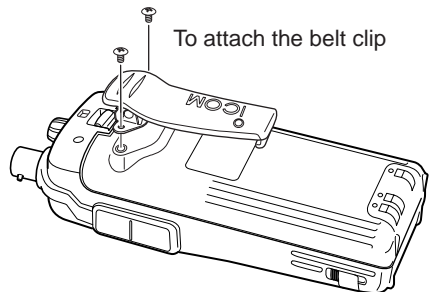

◇ Handstrap (Not supplied)

Slide the hand strap through the loop on the top of the rear panel as illustrated below. Facilitates carrying.

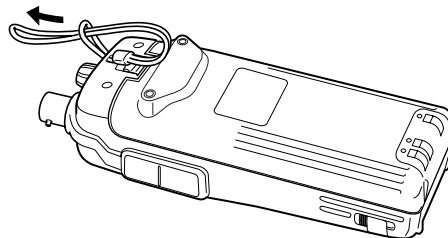

■ Switches, controls, keys and connectors

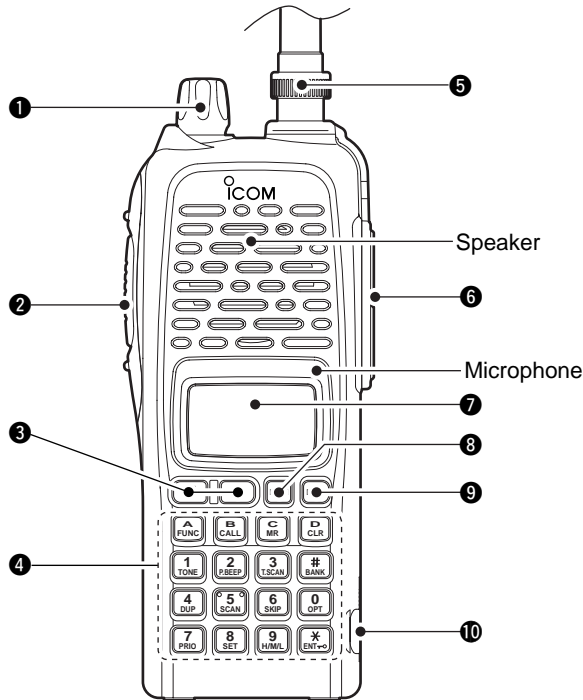

1 CONTROL DIAL [VOL]

*Rotate to adjust the volume level.

2 PTT SWITCH [PTT]

Push and hold to transmit; release to receive.

3 UP/DOWN KEYS [▲]/[▼]

*Selects the operating frequency.

4 KEYPAD (pgs. 4, 5)

Used to enter operating frequency, the DTMF codes, etc.

5 ANTENNA CONNECTOR (p. 1)

Connects the supplied antenna.

6 [SP]/[MIC] JACK

Connect an optional speaker-microphone or headset, if desired. The internal microphone and speaker will not function when a connector is inserted.

7 FUNCTION DISPLAY (pgs. 6, 7)

8 SQUELCH/MONITOR SWITCH [MONI]

Push and hold to force the squelch open, and set the squelch level, if required.

9 POWER SWITCH [PWR]

Push and hold for 1 sec. to turn the power ON and OFF.

*The assigned function for [VOL] and [▲]/[▼] can be exchanged in INITIAL SET MODE (pgs. 14, 65).

2 PANEL DESCRIPTION

10 [DATA] JACK

Connect to a PC or GPS receiver via the RS-232 cable (D-sub 9 pin) for data communication in the RS-232 format.

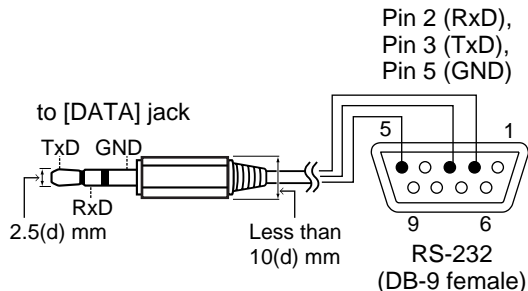

When making the connection between your transceiver and PC or other device, ensure that the correct connections are made otherwise data communications may fail.

◇ Keypad



[A•FUNC]

Access to secondary function.



[B•CALL]

Selects the call channel. (p. 21)



[C•MR]

- ➔ Selects a memory mode. (p. 21)
- ➔ After pushing **[A•FUNC]**, enter into memory programming/editing mode. (pgs. 22–24)
- ➔ After pushing **[A•FUNC]**, programs/transfers VFO/memory or call channel contents into memory channel/VFO when pushed and held for 1 sec. (pgs. 22–24)



[D•CLR]

Selects VFO mode, aborts direct frequency input, or cancels scanning, etc. (pgs. 13, 30)



[1•TONE]

- ➔ Input digit “1” during frequency input, memory channel selection, etc. (pgs. 13, 21)
- ➔ After pushing **[A•FUNC]**, selects the subaudible tone function. (pgs. 17, 34)



[2•P.BEEP]

- ➔ Input digit “2” during frequency input, memory channel selection, etc. (pgs. 13, 21)
- ➔ After pushing **[A•FUNC]**, turns the pocket beep function ON and OFF. (p. 36)



[3•T.SCAN]

- Input digit “3” during frequency input, memory channel selection, etc. (pgs. 13, 21)
- After pushing **[A•FUNC]**, starts tone scanning. (pgs. 19, 37)



[4•DUP]

- Input digit “4” during frequency input, memory channel selection, etc. (pgs. 13, 21)
- After pushing **[A•FUNC]**, selects duplex function (–duplex, +duplex, simplex). (p. 17)



[5•SCAN]

- Input digit “5” during frequency input, memory channel selection, etc. (pgs. 13, 21)
- After pushing **[A•FUNC]**, starts scanning. (p. 30)



[6•SKIP]

- Input digit “6” during frequency input, memory channel selection, etc. (pgs. 13, 21)
- After pushing **[A•FUNC]**, sets and cancels skip setting for memory scan during memory mode. (p. 32)



[7•PRIO]

- Input digit “7” during frequency input, memory channel selection, etc. (pgs. 13, 21)
- After pushing **[A•FUNC]**, starts priority watch. (p. 32)



[8•SET]

- Input digit “8” during frequency input, memory channel selection, etc. (pgs. 13, 21)
- After pushing **[A•FUNC]**, enters into SET MODE. (p. 59)



[9•H/M/L]

- Input digit “9” during frequency input, memory channel selection, etc. (pgs. 13, 21)
- After pushing **[A•FUNC]**, switches transmit power between high, middle and low output power. (p. 15)



[0•OPT]

- Input digit “0” during frequency input, memory channel selection, etc. (pgs. 13, 21)
- After pushing **[A•FUNC]**, selects an optional function mode, such as pager, code squelch or digital operation. (pgs. 40, 42)



[#•BANK]

- After pushing **[A•FUNC]**, enters a memory bank selection. (p. 25)



[*•ENT/O]

- Sets the frequency even if the full 6 digits of frequency have not been entered. (p. 13)
- After pushing **[A•FUNC]**, switches key lock function ON and OFF when pushed and held for 1 sec. Lock all keys, except **[PWR]**, **[PTT]**, **[MONI]** and audio level adjustment. (p. 16)

■ Function display

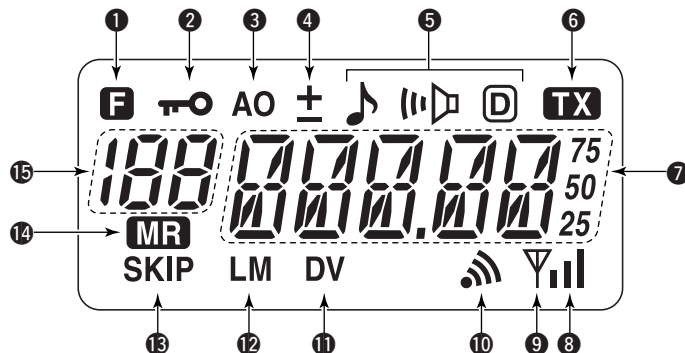

① FUNCTION INDICATOR

Appears while a secondary function is being accessed.

② KEY LOCK INDICATOR (p. 16)

Appears when the key lock function is ON.

③ AUTO POWER OFF INDICATOR (p. 64)

Appears while the auto power OFF function is activated.

④ DUPLEX INDICATOR (p. 17)

Either “-” or “+” appears during repeater operation.

⑤ TONE INDICATOR

○ While in the analog (FM) mode operation

- ➔ “♪” appears while the subaudible tone encoder is in use. (p. 17)
- ➔ “▷” appears while the tone (CTCSS) squelch function is in use. (p. 34)
- ➔ “⊖” appears while the tone (DTCS) squelch function is in use. (p. 34)
- ➔ “|” appears with the “▷” or “⊖” indicator while the pocket beep function (CTCSS or DTCS) is in use. (p. 36)

- While in the digital (DV) mode operation with an optional UT-118 DIGITAL UNIT installed.
 - “D” appears while the digital code (CSQL) squelch function is in use. (p. 49)
 - “@” appears while the call sign (DSQL) squelch function is in use. (p. 49)
 - “u” appears with the “D” or “@” indicator while the pocket beep function (CSQL or DSQL) is in use. (p. 48)

6 TRANSMIT INDICATOR (p. 15)
Appears during transmit.

7 FREQUENCY READOUT
Shows operating frequency, channel number or channel names, depending on display type (p. 16).

8 SIGNAL INDICATOR
➤ Shows receiving signal strength as below.



Weak ← RX Signal level ⇒ Strong

➤ Shows the output power level while transmitting.



9 BUSY INDICATOR
➤ Appears when a signal is being received or the squelch is open.
➤ Blinks while the monitor function is activated. (pgs. 15, 49)

10 PAGER CALL INDICATOR (p. 41)
Blinks when a pager call is received. (This indicator appears only when an optional UT-108 DTMF DECODER UNIT is installed.)

11 DIGITAL MODE INDICATOR (p. 45)
Appears when digital mode is selected. (This indicator appears only when an optional UT-118 DIGITAL UNIT is installed.)

12 LOW/MIDDLE POWER INDICATOR (p. 15)
➤ “L” or “M” appears when the low or middle output power is selected, respectively.
➤ No indicator appears when high output power is selected.

13 SKIP CHANNEL INDICATOR (p. 32)
Appears when the selected memory channel is specified as a skip channel.

14 MEMORY MODE INDICATOR (p. 21)
Appears while in memory mode or channel number indication mode.

15 MEMORY CHANNEL INDICATOR (p. 21)
➤ Shows the selected memory channel number.
➤ “C” appears when the call channel is selected.

3

BATTERY PACKS

■ Battery pack replacement

- ① Before replacing the battery pack, push and hold **[PWR]** for 1 sec. to turn the power OFF.

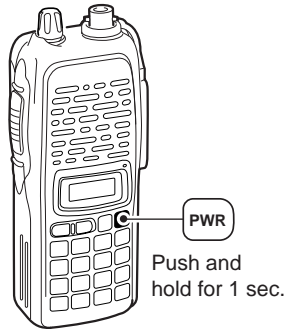

- ② Slide the battery release forward, then pull the battery pack upward with the transceiver facing away from you.

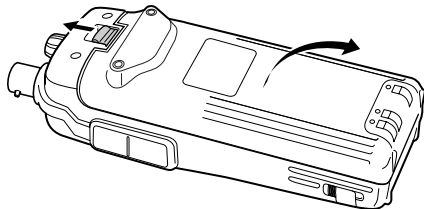

◇ BATTERY PACKS

Battery pack	Voltage	Capacity	Battery life*1	
			IC-V82	IC-U82
BP-208N	Battery case for AA (LR6)×6 alkaline		—*2	
BP-209N	7.2 V	1100 mAh	3 hrs. 20 min.	3 hrs. 40 min.
BP-210N	7.2 V	1650 mAh	6 hrs.	7 hrs.
BP-211N	7.4 V	1800 mAh	6 hrs. 10 min.	8 hrs. 15 min.
BP-222N	7.2 V	600 mAh	2 hrs. 15 min.	2 hrs. 50 min.

*1 Operating periods are calculated under the following conditions;
Tx : Rx : standby = 1 : 1 : 8, power save function: auto setting is activated

*2 Operating period depends on the alkaline cells used.

■ Battery caution

⚠ **DANGER! Use/Charge** the specified Icom batteries only.

Only tested and approved for use with genuine Icom batteries. Fire and/or explosion may occur when a third party battery pack or counterfeit product is used/charged.

- **CAUTION! NEVER** short the terminals of the battery pack (or charging terminals of the transceiver). Also, current may flow into nearby metal objects such as a necklace, so be careful when placing battery packs (or the transceiver) in handbags, etc.

Simply carrying with or placing near metal objects such as a necklace, etc. causes shorting. This will damage not only the battery pack, but also the transceiver.

- **NEVER** incinerate used battery packs. Internal battery gas may cause an explosion.
- **NEVER** immerse the battery pack in water. If the battery pack becomes wet, be sure to wipe it dry **BEFORE** attaching it to the transceiver.
- **Clean** the battery terminals to avoid rust or poor contact.
- **Keep** battery contacts clean. It's a good idea to clean battery terminals once a week.

If your battery pack seems to have no capacity even after being charged, completely discharge it by leaving the power ON overnight. Then, fully charge the battery pack again. If the battery pack still does not retain a charge (or only very little charge), a new battery pack must be purchased (p. 77).

■ Charging NOTE

Prior to using the transceiver for the first time, the battery pack must be fully charged for optimum life and operation.

- Recommended temperature range for charging:
+10°C to +40°C (; +50°F to 140°F)
- Use the supplied charger or optional charger (BC-119N/121N/144N for rapid charging, BC-146 for regular charging) only. **NEVER** use other manufacturers' chargers.

The optional BP-222N, BP-209N, BP-210N or BP-211N battery packs include rechargeable batteries (Ni-Cd: BP-222N, BP-209N, Ni-MH: BP-210N, Li-Ion: BP-211N) and can be charged approx. 300 times. Charge the battery pack before first operating the transceiver or when the battery pack becomes exhausted.

If you want to charge the battery pack more than 300 times, the following points should be observed:

- Avoid over charging. The charging period should be less than 24 hours.
- Use the battery until it becomes almost completely exhausted under normal conditions. We recommend battery charging after transmitting becomes impossible.

◇ Battery pack life

When the operating period becomes extremely short even after charging the battery pack fully, a new battery pack is needed.

3 BATTERY PACKS

■ Battery charging

Recommendation:

Charge the BP-211N (Li-Ion) by BC-119N (or BC-121N) for a maximum of 2.5 hours. Li-Ion batteries are different from Ni-Cd batteries in that it is not necessary to completely charge and discharge them to prolong the battery life. Therefore, charging the battery in intervals, and not for extended periods is recommended.

◇ Regular charging with the BC-146

The optional BC-146 provides regular charging of an optional battery pack with or without a transceiver attached. The following is additionally required:

- An optional AC adapter. (An AD-99N is supplied with BC-146.)

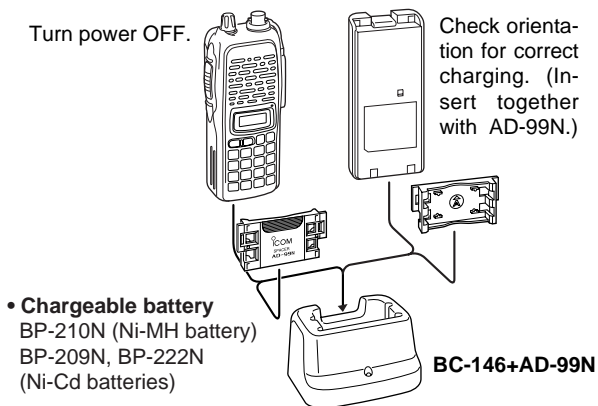

◇ About AD-99N

The adapter (Spacer A) only is required for IC-V82/U82 series. When removing the spacer (Spacer B/C), push the latch carefully with your finger to remove the spacer (Spacer B/C) from the adapter (Spacer A).

Remove the spacer (Spacer B/C) from the adapter.

Push the latch carefully.

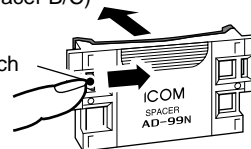

⚠ CAUTION!

- **DO NOT** push or force the latch with a screw driver, etc., to remove it.
- **DO NOT** bend the latch when the adapter and spacer are not joined together. This will cause weakening of the latch plastic.
- Both cases may break the latch and it may not be able to be reattached.

◇ **Rapid charging with the BC-144N**

The optional BC-144N provides rapid charging of optional battery packs.

The following are additionally required:

- An AC adapter (may be supplied with the BC-144N depending on version).

Turn power OFF.

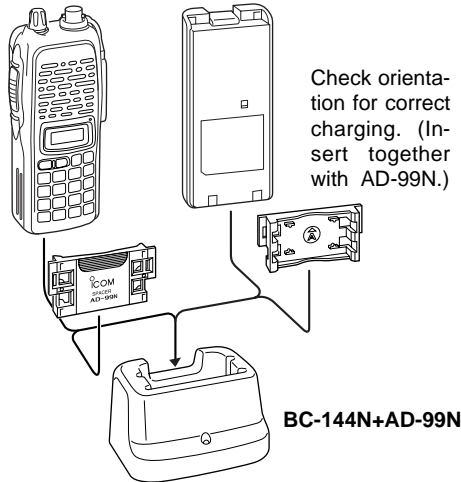

• **Chargeable battery**

- BP-210N (Ni-MH battery)
- BP-209N, BP-222N (Ni-Cd batteries)

◇ **Rapid charging with the BC-119N+AD-101**

The optional BC-119N provides rapid charging of battery packs. The following items are additionally required.

- AD-101 (Charger Adapter).
- An AC adapter (may be supplied with the BC-119N depending on version) or the DC power cable (OPC-515L/CP-17L).

Turn power OFF.

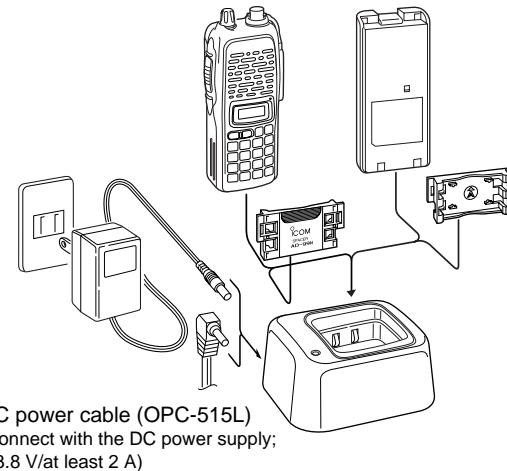

• **Chargeable battery**

- BP-210N (Ni-MH battery)
- BP-209N, BP-222N (Ni-Cd batteries)
- BP-211N (Li-Ion battery)

3 BATTERY PACKS

◇ Rapid charging with the BC-121N+AD-101

The optional BC-121N allows up to 6 battery packs to be charged simultaneously. The following items are additionally required.

- Six AD-101 (Charger Adapter).
- An AC adapter (BC-124; may be supplied with the BC-121N depending on version) or the DC power cable (OPC-656).

Turn power OFF.

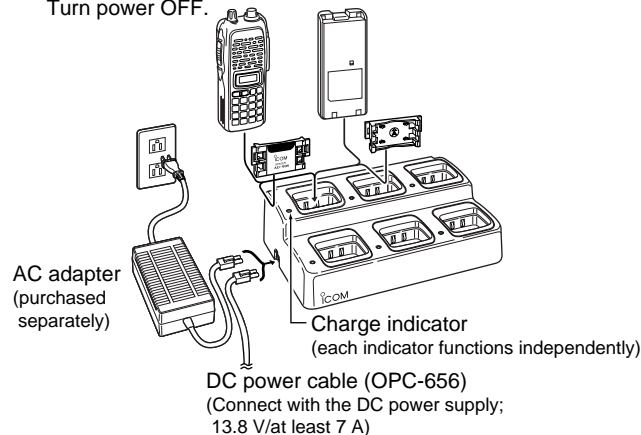

• Chargeable battery

- BP-210N (Ni-MH battery)
- BP-209N, BP-222N (Ni-Cd batteries)
- BP-211N (Li-Ion battery)

■ Battery case (optional for some versions)

When using a BP-208N BATTERY CASE attached to the transceiver, install 6 AA (LR6) size alkaline batteries as illustrated below.

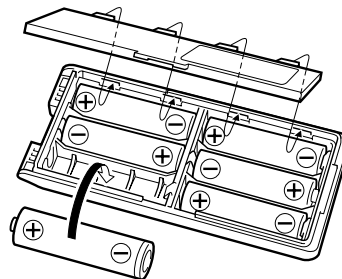

◇ CAUTION

- Use **ALKALINE** batteries only.
- **Make sure** all battery cells are the same brand, type and capacity. **Never** mix old and new batteries. Either of the above may cause a fire hazard or damage the transceiver if neglected.
- **Never** incinerate used battery cells since internal battery gas may cause them to rupture.
- **Never** expose a detached battery case to water. If the battery case gets wet, be sure to wipe it dry before use.

■ Power ON

- ➔ Push and hold [PWR] for 1 sec. to turn power ON.



■ VFO mode selection

The transceiver has 2 basic operating modes: VFO mode and memory mode.

- ➔ Push [D•CLR] to select VFO mode.

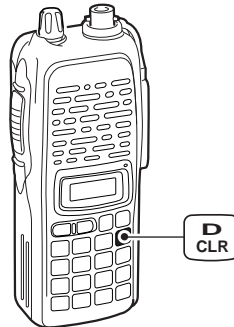

■ Setting a frequency

◇ Via the keypad

- ① Push [D•CLR] to select VFO mode, if necessary.
- ② To enter the desired frequency, enter 6 digits starting from the 100 MHz digit.
 - Entering three* to five digits then pushing [*•ENT ↵] will also set the frequency. (*Some versions only requires two digits.)
 - When a digit is mistakenly input, push [D•CLR] to abort input.

• Example 1— when entering 145.525 MHz

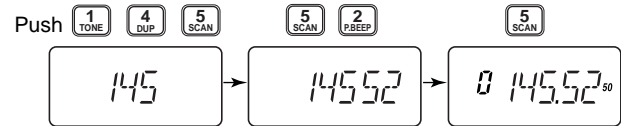

• Example 2— when entering 144.800 MHz

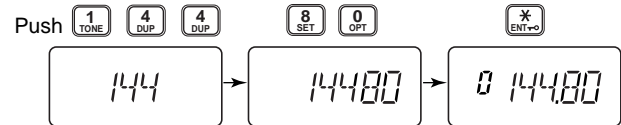

4 BASIC OPERATION

◇ By other methods

Via the [▲]/[▼] keys

- Push [▲] or [▼] several times to set the desired frequency.
 - Each push increases/decreases the frequency by the selected tuning step. See next set of instructions for setting tuning step size.

◇ Tuning step selection

The IC-V82/U82 has 8 tuning steps— 5, 10, 12.5, 15, 20, 25, 30 and 50 kHz. The tuning step is selectable in SET MODE.

- ① Push [A•FUNC] then [8•SET] to enter SET MODE.
- ② Push [▲] or [▼] several times to select the tuning step item.

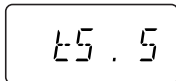

- ③ Rotate [VOL] to select the desired tuning step.
- ④ Push [*•ENT•>] to exit SET MODE.

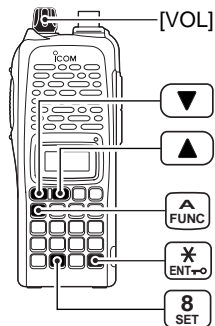

✓ For your information— [VOL] function assignment

The [VOL] control can be used as a tuning dial for frequency tuning instead of [▲]/[▼] keys. However, when [VOL] functions as tuning dial, [▲]/[▼] keys functions as volume control.

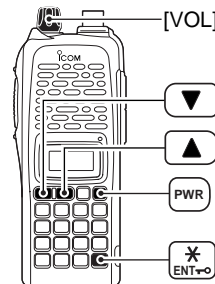

- ① While pushing [▲] and [▼], turn power ON to enter INITIAL SET MODE.
- ② Push [▲] or [▼] several times to select the dial assignment item, "tOP."
- ③ Rotate [VOL] to select the condition.

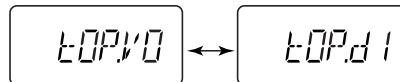

[VOL] is assigned as AF volume control. [VOL] is assigned as tuning dial.

- ④ To exit SET MODE, push [*•ENT•>].

■ Setting audio/squelch level

◇ To set the audio level

Rotate **[VOL]** to set the desired audio level while receiving a signal.

- When no signal is received, push and hold **[MONI]** while setting the audio level.
- When **[VOL]** is assigned as tuning dial, push **[▲]/[▼]** to adjust the audio output level. (pgs. 14, 65)

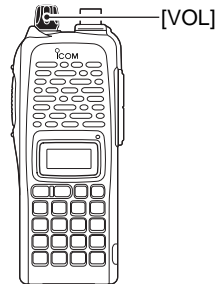

◇ To set the squelch level

While pushing **[MONI]**, push **[▲]/[▼]** to set the squelch level.

- The squelch level "1" is loose squelch, "10" is tight squelch.
- When **[VOL]** is assigned as tuning dial, rotate **[VOL]** while pressing **[MONI]**. (pgs. 14, 65)

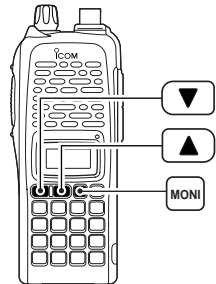

■ Receive and transmit

- ① Push and hold **[PWR]** for 1 sec. to turn the power ON.
- ② Adjust audio volume to the desired level.
- ③ Set the frequency.
 - When a signal is received:
 - Squelch opens and audio is emitted from the speaker.
 - Signal indicator shows the relative signal strength level.
- ④ Push **[A•FUNC]**, then **[9•H/M/L]** to select output power between high, middle and low.
 - "L" appears when low power is selected.
 - "M" appears when middle power is selected.
 - No indication appears when high power is selected.
- ⑤ Push and hold **[PTT]** to transmit, then speak into the microphone.
 - "**TX**" appears.
 - **Do not** hold the microphone too close to your mouth or speak too loudly. This may distort the signal.
- ⑥ Release **[PTT]** to receive.

✓ For your information— Monitor function:

Push and hold **[MONI]** to listen to weak signals that do not open the squelch.

4 BASIC OPERATION

■ Display type

USING INITIAL SET MODE

The transceiver has 3 display types to suit your operating style during memory mode operation. The display type is selected in INITIAL SET MODE (p. 65).

“Frequency Indication” type

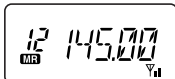

Displays operating frequency.

“Channel Number Indication” type

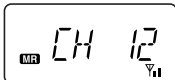

Displays memory channel number. In this type only pre-programmed memory channel numbers are displayed.

VFO mode cannot be selected.

- When the channel indication type is selected, only the following functions can be performed.
 - Scan function (p. 30)
 - Output power setting (p. 15)
 - DTMF memory function (p. 27)
 - Key lock function (see next set of instructions)
 - Scan pause timer setting, function key timer setting and LCD backlight setting in SET MODE (p. 61)

“Channel Name Indication” type

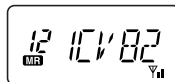

Displays memory channel name you have assigned. In this display pre-programmed memory channel names are displayed.

VFO mode is selectable.

- Programmed frequencies are indicated when you have not pre-programmed the channel names in the selected memory channel.
- Push and hold [MONI] to display the operating frequency.

■ Key lock function

The key lock function prevents accidental frequency changes and function activation.

Push [A•FUNC] then push and hold [*•ENT•] for 1 sec. to toggle the function ON and OFF.

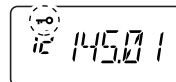

- “**LO**” appears while the lock function is activated.
- [PWR], [PTT], [VOL] and [MONI] can be operated regardless of this setting.

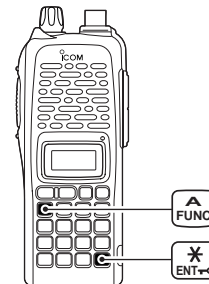

■ General

When using a repeater, the transmit frequency is shifted from the receive frequency by the offset frequency. It is convenient to program repeater information into memory channels.

- ① Set the receive frequency (repeater output frequency).
- ② Push **[A•FUNC]** and **[4•DUP]** several times to select “-” or “+.”
 - “-” indicates the transmit frequency is shifted down; “+” indicates the transmit frequency is shifted up.
 - Blinking “-” or “+” indicates the reversed duplex mode is selected in SET MODE (p. 58).
- ③ Push **[A•FUNC]** and **[1•TONE]** several times to activate the subaudible tone encoder, if required.
 - “J” appears.
 - Select the desired subaudible tone frequency, if necessary. (p. 18)
- ④ Push and hold **[PTT]** to transmit.
 - The displayed frequency automatically changes to the transmit frequency (repeater input frequency).
 - If “OFF” appears, check the offset frequency (see next page for details) and direction.
- ⑤ Release **[PTT]** to receive.
- ⑥ Push and hold **[MONI]** to check whether the other station’s transmit signal can be directly received.

■ Reversed duplex mode

USING SET MODE

When the reversed duplex mode is selected, the receive frequency shifts. (Transmit frequency shifts in normal duplex mode.) Each receive and transmit frequency is shown in the table below with the following conditions;

IC-V82

Input frequency : 145.30 MHz
 Direction : – (negative)
 Offset frequency : 0.6 MHz

IC-U82

Input frequency : 439.80 MHz
 Direction : – (negative)
 Offset frequency : 5 MHz

Reversed	IC-V82		IC-U82	
	OFF	ON	OFF	ON
Rx freq.	145.30 MHz	144.70 MHz	439.80 MHz	434.80 MHz
Tx freq.	144.70 MHz	145.30 MHz	434.80 MHz	439.80 MHz

- ① Push **[A•FUNC]**, then push **[8•SET]** to enter SET MODE.
- ② Push **[▲]** or **[▼]** several times until “REV” appears.
- ③ Rotate **[VOL]** to turn the reversed duplex mode ON or OFF.
- ④ Push **[*•ENT↵]** (or **[D•CLR]**) to exit SET MODE.

5 REPEATER OPERATION

■ Offset frequency USING SET MODE

When communicating through a repeater, the transmit frequency is shifted from the receive frequency by an amount determined by the offset frequency.

- ① Push [**A•FUNC**], then push [**8•SET**] to enter SET MODE.
- ② Push [**▲**] or [**▼**] several times until “±” and offset frequency appear.

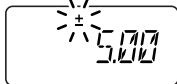
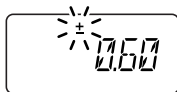

- ③ Rotate [**VOL**] to select the desired offset frequency.
 - Selectable steps are the same as the pre-set tuning steps.
 - The unit of the displayed offset frequency is “MHz.”
- ④ Push [***•ENT•O**] (or [**D•CLR**]) to set the offset frequency and exit SET MODE.

■ Subaudible tones USING SET MODE

Some repeaters require subaudible tones to be accessed. Subaudible tones are added to your normal signal and must be set in advance.

- ① Push [**A•FUNC**], then push [**8•SET**] to enter SET MODE.
- ② Push [**▲**] or [**▼**] one or more times until “rt” appears.

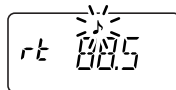

- ③ Rotate [**VOL**] to select the desired subaudible tone.
- ④ Push [***•ENT•O**] (or [**D•CLR**]) to set the selected tone and exit SET MODE.

• Available subaudible tone frequencies (unit: Hz)

67.0	85.4	107.2	136.5	165.5	186.2	210.7	254.1
69.3	88.5	110.9	141.3	167.9	189.9	218.1	
71.9	91.5	114.8	146.2	171.3	192.8	225.7	
74.4	94.8	118.8	151.4	173.8	196.6	229.1	
77.0	97.4	123.0	156.7	177.3	199.5	233.6	
79.7	100.0	127.3	159.8	179.9	203.5	241.8	
82.5	103.5	131.8	162.2	183.5	206.5	250.3	

◇ Tone information

Some repeaters require different tone system to be accessed.

DTMF TONES

While pushing [PTT], push the desired DTMF keys (0–9, [A•FUNC], [B•CALL], [C•MR], [D•CLR], [#•BANK] and [*•ENT↔O]) to transmit DTMF tones.

- [*•ENT↔O] transmits tone “E,” [#•BANK] transmits tone “F.”
- The transceiver has 16 DTMF memory channels (p. 27).

1750 Hz TONE

While pushing [PTT], push [▲] or [▼] to transmit a 1750 Hz tone signal.

✓ Convenient

Tone scan function: When you don’t know the subaudible tone used for a repeater, the tone scan is convenient for detecting the tone frequency.

Push [A•FUNC], then push [3•T.SCAN] to start the tone scan.

- Push [D•CLR] to cancel the scan.
- When the required tone frequency is detected, the scan pauses.

■ Repeater lockout

USING INITIAL SET MODE

This function helps prevent interference to other stations by inhibiting your transmission when a signal is received. The transceiver has two inhibiting conditions, repeater and busy.

- ① While pushing and holding [▲] and [▼], turn the power ON to enter INITIAL SET MODE.
- ② Push [▲] or [▼] several times until “RLO” appears.
- ③ Rotate [VOL] to select the repeater lockout function to “RP,” “bU” or OFF.
 - “RP”: Transmit is inhibited when a signal with un-matched sub-audible tone is received.
 - “bU”: Transmit is inhibited when a signal is received.

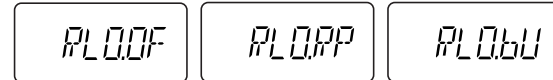

- ④ Push [*•ENT↔O] (or [D•CLR]) to exit INITIAL SET MODE.

5 REPEATER OPERATION

■ Auto repeater function (USA/CSA versions only)

USING INITIAL SET MODE

The USA/CSA versions automatically activate the repeater settings (duplex ON/OFF, duplex direction, tone encoder ON/OFF) when the operating frequency falls within or outside of the general repeater output frequency range. The offset and repeater tone frequencies are not changed by the auto repeater function. Reset these frequencies, if necessary.

- ① While pushing and holding [▲] and [▼], turn the power ON to enter INITIAL SET MODE.
- ② Push [▲] or [▼] several times until "RPt" appears.
- ③ Rotate [VOL] to select the desired condition.
 - "OF"— the auto repeater function is turned OFF;
 - "R1"— the auto repeater function activates duplex only;
 - "R2"— the auto repeater function activates duplex and tone.

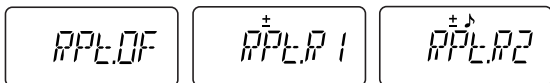

- ④ Push [*ENT] (or [D•CLR]) to exit INITIAL SET MODE.

• Frequency range and offset direction

Frequency range	Duplex direction
145.200–145.495 MHz 146.610–146.995 MHz	“–” appears
147.000–147.395 MHz	“+” appears
442.000–444.995 MHz	“+” appears
447.000–449.995 MHz	“–” appears

■ General description

The transceiver has 207 memory channels including 6 scan edge memory channels (3 pairs), and 1 call channel. Each of these channels can be individually programmed with operating frequency (pgs. 13, 14), duplex direction (p. 17) and offset (p. 18), subaudible tone encoder or tone squelch and its tone frequency (pgs. 18, 35) and skip information* (p. 32).

*except for scan edge memory channels.

In addition, a total of 10 memory banks, A to J, are available for usage by group, etc.

5

6

■ Selecting a memory channel

① Push **[C•MR]** to select memory mode.

- “**MR**” appears.

Push 

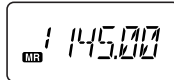

② Enter 2 digits to select the desired memory channel (or push the **[▲]/[▼]** keys).

- The memory channels 0–9 are preceded by a “0.”
- When **[VOL]** is assigned as tuning dial, rotate **[VOL]** to select the memory channel. (pgs. 14, 65)

Push  

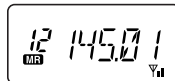

■ Selecting the call channel

➔ Push **[B•CALL]** to select the call channel.

- “**C**” is displayed instead of the memory channel number.
- Push **[D•CLR]** or **[C•MR]** to select VFO or memory mode, respectively.

Push 

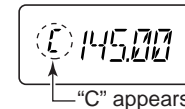

■ Programming the memory/call channels

- ① Push **[D•CLR]** to select VFO mode, if necessary.
- ② Set the desired frequency.
- ③ Set other information, such as tone, duplex, as desired.
- ④ Push **[A•FUNC]**, then **[C•MR]** momentarily.
 - “**MR**” and memory channel number blink.

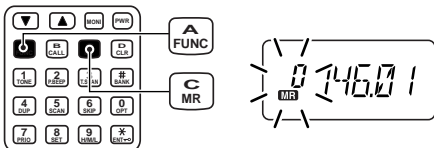

- ⑤ Push **[▲]** or **[▼]** to select the desired memory channel.
 - When programming the call channel, select “C.”
 - When **[VOL]** is assigned as tuning dial, rotate **[VOL]** to select the memory channel. (pgs. 14, 65)

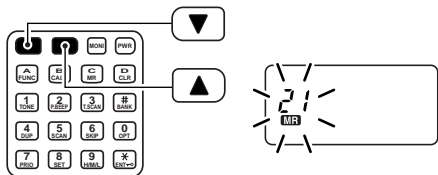

- ⑥ Push **[A•FUNC]**, then push and hold **[C•MR]** for 1 sec., when 3 beeps will sound to program the information into the selected memory channel and return to VFO.

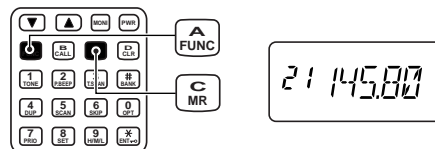

- After 3 beeps are emitted, continue to hold **[C•MR]** to increment the displayed memory channel number.

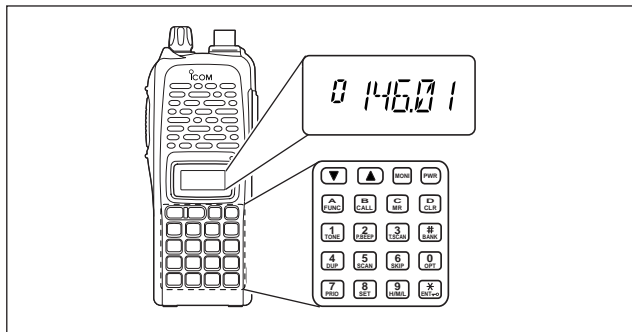
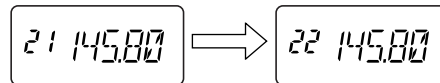

■ Channel name programming

- ① Select a “Channel Name Indication” type in INITIAL SET MODE (p. 65).
- ② Push **[C•MR]** to select memory mode, if necessary.
- ③ Push **[A•FUNC]**, then push **[8•SET]** to enter into the channel name programming mode.
 - The character to be edited blinks.
- ④ Rotate **[VOL]** to select a character.

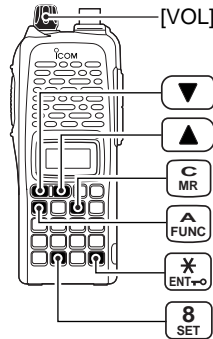

- ⑤ Push **[▲]** to move the cursor to right, **[▼]** to move the cursor to left.
 - Up to 5 characters can be used for channel name.
 - Usable characters are A–Z, 0–9, “space,” +, –, =, *, /, [,] and :.
- ⑥ Push **[*•ENT]** (or **[D•CLR]**) to set the name and exit the channel name programming mode.

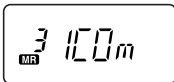

■ Memory transfers

This function transfers a memory channel’s contents to VFO (or another memory/call channel). This is useful when searching for signals around a memory channel frequency and for recalling the offset frequency, subaudible tone frequency etc.

◇ Memory/call ⇒ VFO

- ① Select the memory (call) channel to be transferred:
 - Push **[C•MR]** (or **[B•CALL]**) to select memory (call) mode.
 - Push **[▲]** or **[▼]** to select the memory channel.
 - When **[VOL]** is assigned as tuning dial, rotate **[VOL]** to select the memory channel. (pgs. 14, 65)
- ② Push **[A•FUNC]**, then push and hold **[C•MR]** for 1 sec. to transfer the selected memory contents to the VFO.
 - VFO mode is selected automatically.

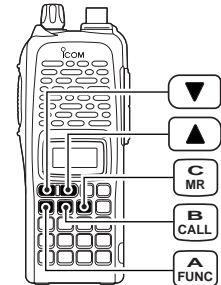

6 MEMORY/CALL OPERATION

◇ Memory/call ⇒ memory/call

- ① Select the memory (call) channel to be transferred:

➔ Push [**C•MR**] (or [**B•CALL**]) to select the memory (call) mode.

➔ Push [**▲**] or [**▼**] to select the memory channel.

- When [**VOL**] is assigned as tuning dial, rotate [**VOL**] to select the memory channel. (pgs. 14, 65)

- ② Push [**A•FUNC**], then push [**C•MR**] momentarily.

- “-” and “**MR**” blink.

- ③ Push [**▲**] or [**▼**] to select the target memory.

- When [**VOL**] is assigned as tuning dial, rotate [**VOL**] to select the target channel. (pgs. 14, 65)

- ④ Push [**A•FUNC**], then push and hold [**C•MR**] for 1 sec.

- Memory mode is selected and the contents are transferred to the target memory.

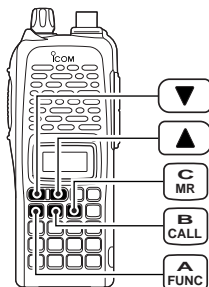

◇ Clearing a memory

- ① Push [**A•FUNC**], then push [**C•MR**] to enter the memory transfer mode.

- “**MR**” and a memory channel number blink.

- ② Push [**▲**] or [**▼**] to select the memory channel to be cleared.

- When [**VOL**] is assigned as tuning dial, rotate [**VOL**] to select the memory channel. (pgs. 14, 65)

- The call channel cannot be cleared.

- ③ Perform the following operation within 1.5 sec, otherwise the transceiver returns to the memory mode without clearing the memory.

- Push [**A•FUNC**], then push [**C•MR**] momentarily.

- Push [**A•FUNC**], then push and hold [**C•MR**] for 1 sec.

- The contents of the selected memory are cleared.

- ④ Push [**D•CLR**] to return to regular operation.

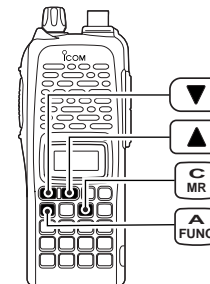

Memory bank selection

The IC-V82/U82 has a total of 10 banks (A to J). Each memory channel, 0 to 199, may be assigned to one of the banks for easy memory management.

- 1 Push **[C•MR]** to select memory mode.



- 2 Push **[A•FUNC]** and **[#•BANK]** to enter memory bank selection.
 - Bank indicator blinks.

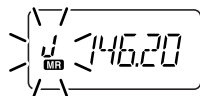

- 3 Rotate **[VOL]** to select the desired bank, A to J.
 - Banks that have no programmed contents are skipped.
- 4 Push **[*•ENT•>]** (or **[D•CLR]**) to select the bank.
 - Indicator stops blinking.
- 5 Push **[▲]** or **[▼]** to select the channel in the bank.
 - No channel numbers are displayed for memory bank operation.
- 6 To return to regular memory condition, push **[A•FUNC]** and **[#•BANK]** to enter memory bank mode, then push **[*•ENT•>]** (or **[D•CLR]**).

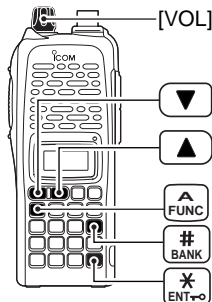

Memory bank setting

- 1 Push **[C•MR]** to select memory mode, then select the desired memory channel via **[▲]** or **[▼]**.



- 2 Push **[A•FUNC]** and **[8•SET]** to enter SET MODE.
- 3 Push **[▲]** or **[▼]** several times until "bAK" appears.
 - "—" indication blinks as follows.

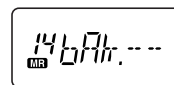

- 4 Rotate **[VOL]** to select the desired bank.

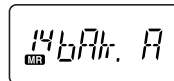

- 5 Push **[*•ENT•>]** (or **[D•CLR]**) to assign the channel to the bank and return to regular memory condition.
- 6 Repeat steps 1 to 5 to assign another memory channel to the same or another bank.

NOTE: Display type setting (pgs. 16, 65) in INITIAL SET MODE must be selected "FR," otherwise the memory bank operation cannot be performed.

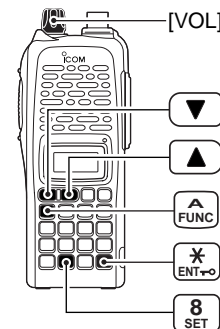

6 MEMORY/CALL OPERATION

■ Transferring bank contents

Contents of programmed memory banks can be cleared or transferred to another bank.

/// INFORMATION: Even if the memory bank contents are cleared, the memory channel contents still remain programmed.

① Select the desired bank contents to be transferred or erased.

➔ Push [**C•MR**] to select memory mode.

➔ Push [**A•FUNC**] and [**#•BANK**], then rotate [**VOL**] to select the desired memory bank.

• Bank indicator blinks.

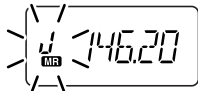

➔ Push [***•ENT•>**] (or [**D•CLR**]) to select the bank then push [**▲**] and [**▼**] to select the desired contents.

• Bank indicator stops blinking.

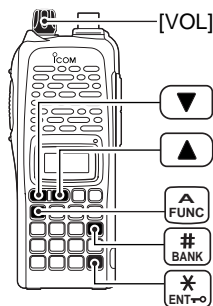

② Push [**A•FUNC**] and [**8•SET**] to enter SET MODE.

③ Push [**▲**] or [**▼**] several times until “bAk” appears.

• Bank indicator appears.

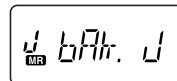

④ Rotate [**VOL**] to select the desired bank to receive the transferred information or erase the bank contents.

• Select “—” indication when erasing the contents from the bank.

⑤ Push [***•ENT•>**] (or [**D•CLR**]) to transfer or erase, and return to regular memory mode.

⑥ Repeat steps ① to ⑤ for transferring or erasing an another bank's contents.

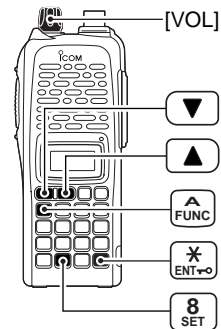

■ Programming a DTMF code sequence

The transceiver has 16 DTMF memory channels (d0 to dF) for storage of often-used DTMF code sequence of up to 24 digits. DTMF memories are used to store phone numbers or control codes.

- Push **[A•FUNC]**, then push **[0•OPT]** to enter OPTION SET MODE.
 - Rotate **[VOL]** to select “dtm.OF,” if necessary. Or when an optional UT-118 DIGITAL UNIT is installed, push **[▲]** or **[▼]** several times until “dtm.OF” appears.



- Push and hold **[0•OPT]** for 1 sec. to select the DTMF memory.
 - One of “d0” to “dF” appears.

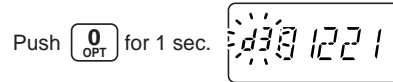

- Rotate **[VOL]** to select the desired DTMF memory.
- Push and hold **[0•OPT]** for 1 sec. to enter the DTMF programming mode.
 - “_____” appears.
 - Programmed memories can be cleared in this way.

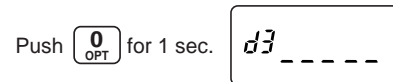

- Enter the desired DTMF code sequence by pushing the digit keys, **[A•FUNC]**, **[B•CALL]**, **[C•MR]**, **[D•CLR]**, **[#•BANK]** and **[*•ENT→O]**, in the desired sequence.
 - A maximum of 24 digits can be input.
 - [*•ENT→O]** enters tone “E”, **[#•BANK]** enters tone “F.”
 - If a digit is mistakenly input, push **[MONI]** or **[PTT]** momentarily then repeat from step ①.

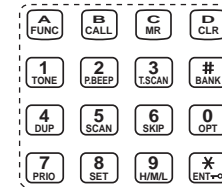

- Push **[MONI]** or **[PTT]** to save the digits and exit the DTMF programming mode.
 - Programmed DTMF code sequence sounds when **[MONI]** is pushed.
 - Or after 24th digit is input, the transceiver automatically saves the digits and returns to step ②.

• DTMF memory indication

The DTMF memory consists of 5 pages that are 1st to 5th, 6th to 10th, 11th to 15th, 16th to 20th and 21st to 24th digits.

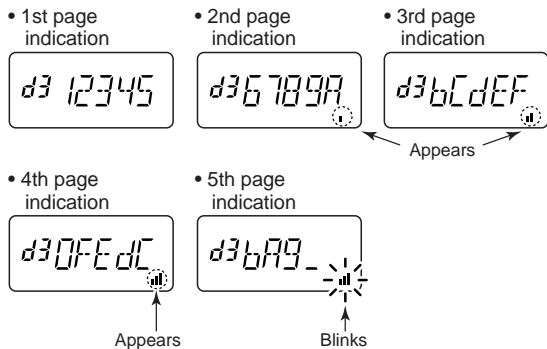

■ Transmitting a DTMF code sequence

◇ Using a DTMF memory channel

- ① Push **[A•FUNC]**, then push **[0•OPT]** to enter OPTION SET MODE.
 - Rotate **[VOL]** to select "dtm.OF," if necessary.



- ② Push and hold **[0•OPT]** for 1 sec. to select the DTMF memory.

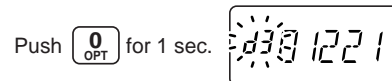

- ③ Rotate **[VOL]** to select the desired memory.
- ④ Push **[MONI]** or **[PTT]** to exit the DTMF memory mode.
 - Selected DTMF code sequence sounds when **[MONI]** is pushed.
- ⑤ While pushing **[PTT]**, push **[MONI]** to transmit the selected DTMF memory.
 - After the DTMF code sequence is transmitted, the transceiver returns to receive automatically.

◇ Manual DTMF code transmission

While pushing [PTT], push digit keys, [A•FUNC], [B•CALL], [C•MR], [D•CLR], [#•BANK] and [*•ENT↵] to transmit a DTMF code sequence manually.

- [*•ENT↵] transmits tone “E”, [#•BANK] transmits tone “F.”

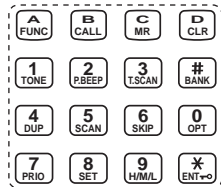
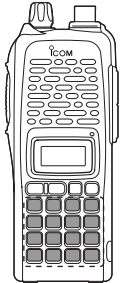

■ DTMF transmission rate

USING INITIAL SET MODE

When slow DTMF transmission rates are required with DTMF memory transmission (as for some repeaters), the transceiver's rate of DTMF transmission can be adjusted.

- ① While pushing and holding [▲] and [▼], turn the power ON to enter INITIAL SET MODE.
- ② Push [▲] or [▼] several times until “dtd” appears.
- ③ Rotate [VOL] to select the desired DTMF transmission rate.
 - Four rates are available: “1” (100 msec. intervals) is the fastest; “5” (500 msec. intervals) is the slowest.

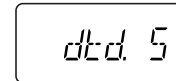
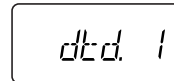
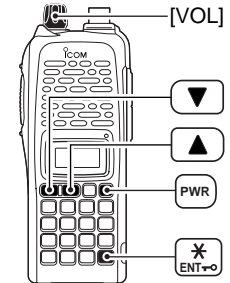

- ④ Push [*•ENT↵] to exit INITIAL SET MODE.

Scan types

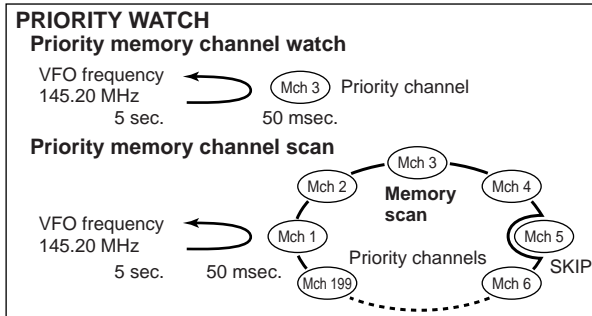
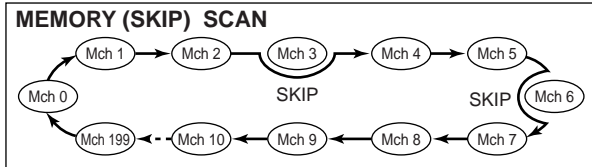
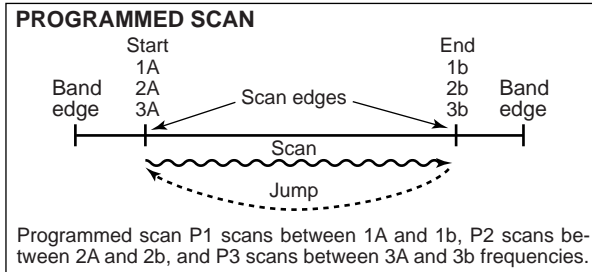

Programmed scan

Programmed scan repeatedly scans between two user programmed frequencies (memory channels “1A–3A” and “1b–3b”) or scans between upper and lower band edges. This scan is useful for checking for signals within a specific frequency range such as repeater output frequencies, etc. Scans between lower (start) and high (stop) frequency.

- ① Push **[D•CLR]** to select VFO mode, if necessary.
- ② Push **[A•FUNC]** and **[5•SCAN]** to start the scan, then a selected scan edge appears as “P1,” “P2,” “P3” or “AL.”
 - To change the scan edge, push **[A•FUNC]** and **[8•SET]** several times until the desired scan edge appears.
 - “AL” for full scan, “P1,” “P2” and “P3” for programmed scan between the programmed scan edge channels as “1A”–“1b,” “2A”–“2b” and “3A”–“3b.”
 - To change the scan direction, push **[▲]** or **[▼]**.
 - When **[VOL]** is assigned as tuning dial, rotate **[VOL]** to change the scan direction. (pgs. 14, 65)



- ③ Push **[D•CLR]** to stop the scan.

NOTE: Scan edges, 1A–3A/1b–3b, must be programmed in advance. Program them in the same manner as regular memory channels. (p. 22)
 If identical frequencies are programmed into the scan edges, programmed scan will not proceed.

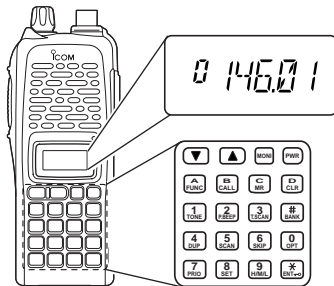

Memory scan

Memory scan repeatedly scans all programmed memory channels, except those set as skip channels.

- ① Push **[C•MR]** to select memory mode, if necessary.
 - “**MR**” appears.
 - See below to select bank scan.
- ② Push **[A•FUNC]** and **[5•SCAN]** to start the scan.
 - To change the scan direction, push **[▲]** or **[▼]**.
 - When **[VOL]** is assigned as tuning dial, rotate **[VOL]** to change the scan direction. (pgs. 14, 65)



- ③ Push **[D•CLR]** to stop the scan.

• **Bank scan** — Select the desired bank in step ① above.

- ① Push **[A•FUNC]** and **[#•BANK]** to select memory bank mode.

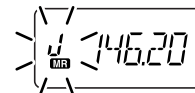

- ② Rotate **[VOL]** to select the desired bank, A to J.
- ③ Push **[*•ENT↵]** (or **[D•CLR]**) to select the bank.

8 SCAN OPERATION

■ Skip channels

In order to speed up the scan rate, you can select memory channels you don't wish to scan as skip channels.

- ① Push **[C•MR]** to select memory mode, if necessary.
 - “MR” appears.
- ② Select a memory channel to set as a skip channel.
- ③ Push **[A•FUNC]** and **[6•SKIP]** to toggle the skip setting ON and OFF.
 - “SKIP” appears when the channel is set as a skip channel.

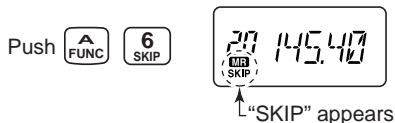

■ Priority watch

Priority watch checks for signals on “priority channels” while operating on a VFO frequency.

◇ Memory or call channel watch

While operating on a VFO frequency, memory or call channel watch monitors for signals in the selected memory or call channel every 5 sec.

- ① Select the desired memory channel or the call channel.
- ② Push **[D•CLR]** to select VFO mode.
- ③ Push **[A•FUNC]**, then push **[7•PRIO]** to start watching.
 - VFO is displayed, then the decimal point “.”, on the frequency readout blinks.
 - The priority channel is monitored every 5 sec.
 - When the signal is detected on the priority channel, the watching is suspended according to the setting of the scan resume condition.

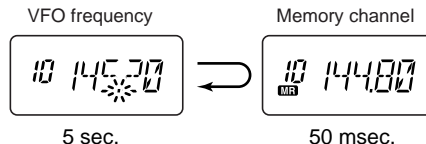

- ④ Push **[D•CLR]** to stop watching.

◇ Memory scan watch

While operating on a VFO frequency, memory scan watch monitors for signals in each memory channel in sequence, every 5 sec.

- ① Push [**C•MR**] to select memory mode, if necessary.
 - “**MR**” appears.
- ② Push [**A•FUNC**], then push [**5•SCAN**] to start the memory scan.
- ③ Push [**A•FUNC**], then push [**7•PRIO**] to start the watching.
 - VFO is displayed, then the decimal point “.”, on the frequency readout blinks.
 - When the signal is detected on the priority channel, the watching is suspended according to the setting of the scan resume condition.

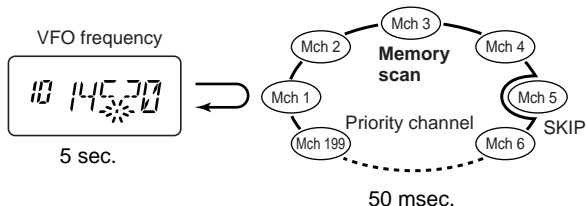

- ④ Push [**D•CLR**] to stop the watching.

■ Scan resume condition

USING SET MODE

When a signal is received during scanning, the scan resume condition determines what action the transceiver takes. The transceiver has 2 scan resume conditions available as illustrated below. Use SET MODE to select the one which best suits your needs.

- ① Push [**A•FUNC**], then push [**8•SET**] to enter SET MODE.
- ② Push [**▲**] or [**▼**] several times until “SCP” or “SCL” appears.
- ③ Rotate [**VOL**] to select the desired scan resume condition.

• **Pause scan:**

When receiving a signal, scan pauses on the signal until it disappears. Resumes 2 sec. after the signal disappears.

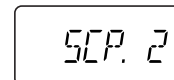

Pause scan

• **Timer scan:**

When receiving a signal, scan pauses on the signal for 5 sec., 10 sec. or 15 sec., then resumes.

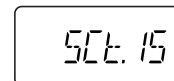

Timer scan

- ④ Push [***•ENT•O**] (or [**D•CLR**]) to set and exit SET MODE.

■ Tone squelch

◇ Operation

The tone squelch opens only when receiving a signal containing a matching subaudible tone. You can wait for calls from group members using the same tone and not hear other signals.

- ① Set the operating frequency.
 - Set the volume and squelch to the desired level as the normal operation.
- ② Set the desired subaudible tone in SET MODE.
 - See page 35 for programming.
- ③ Push **[A•FUNC]**, then push **[1•TONE]**.
 - Repeat several times until “**▷**” appears when selecting CTCSS, or “**Ⓢ**” appears when selecting DTCS.

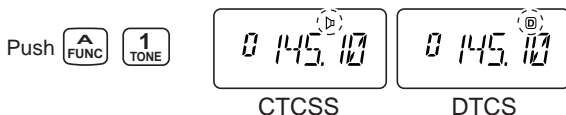

- ④ When the received signal includes a matching tone, squelch opens and the signal can be heard.
 - When the received signal's tone does not match, tone squelch does not open, however, the S-indicator shows signal strength.
 - To open the squelch manually, push and hold **[MONI]**.
- ⑤ Transmit in the normal way.
- ⑥ To cancel the tone squelch, push **[A•FUNC]** and **[1•TONE]**.
 - Repeat several times until “**▷**” or “**Ⓢ**” disappears.

NOTE: The transceiver has 50 tone frequencies and consequently their spacing is narrow compared to units having 38 tones. Therefore, some tone frequencies may receive interference from adjacent tone frequencies. To prevent interference from adjacent tone frequencies, using the frequencies as in the following table, is recommended.

• Recommended CTCSS frequencies (Unit: Hz)

67.0	79.7	94.8	110.9	131.8	156.7	186.2	225.7
69.3	82.5	97.4	114.8	136.5	162.2	192.8	233.6
71.9	85.4	100.0	118.8	141.3	167.9	203.5	241.8
74.4	88.5	103.5	123.0	146.2	173.8	210.7	250.3
77.0	91.5	107.2	127.3	151.4	179.9	218.1	

• Recommended DTCS codes

023	051	114	143	174	251	315	371	445	532	631	723
025	054	115	152	205	261	331	411	464	546	632	731
026	065	116	155	223	263	343	412	465	565	654	732
031	071	125	156	226	265	346	413	466	606	662	734
032	072	131	162	243	271	351	423	503	612	664	743
043	073	132	165	244	306	364	431	506	624	703	754
047	074	134	172	245	311	365	432	516	627	712	

◇ Setting subaudible tones for tone squelch operation

Separate tone frequencies can be select for tone squelch operation rather than repeater operation (the same range of tones is available— see right below). Like the repeater tones, these are set in SET MODE.

- ① Select VFO or memory channel.
- ② Push [A•FUNC], then push [8•SET] to enter SET MODE.
- ③ Push [▲] or [▼] several times until “Ct” appears when selecting CTCSS, or “dt” appears when selecting DTCS.
 - “Ct” blinks when selecting CTCSS, or “dt” blinks when selecting DTCS.



- ④ Rotate [VOL] to select the desired subaudible tone.
- ⑤ Push [*•ENT↔] (or [D•CLR]) to program the selected tone and exit SET MODE.
 - The recommended CTCSS frequencies or DTCS codes are shown at previous page.

When SET MODE is selected from memory mode.

The tone squelch frequency is not stored in the selected memory channel unless you follow steps ⑥ and ⑦.

- ⑥ Push [A•FUNC], then push and hold [C•MR] for 1 sec. to transfer the contents to VFO.
 - 3 beeps are emitted.
 - VFO mode is selected automatically.
- ⑦ Push [A•FUNC], then push and hold [C•MR] for 1 sec.
 - 3 beeps are emitted.

• Available CTCSS tone frequency list (unit: Hz)

67.0	85.4	107.2	136.5	165.5	186.2	210.7	254.1
69.3	88.5	110.9	141.3	167.9	189.9	218.1	
71.9	91.5	114.8	146.2	171.3	192.8	225.7	
74.4	94.8	118.8	151.4	173.8	196.6	229.1	
77.0	97.4	123.0	156.7	177.3	199.5	233.6	
79.7	100.0	127.3	159.8	179.9	203.5	241.8	
82.5	103.5	131.8	162.2	183.5	206.5	250.3	

■ Pocket beep operation

This function listens for subaudible tones and can be used as a “common pager” to inform you that someone has called when you were away from the transceiver.

◇ Waiting for a call from a specific station

- ① Set the operating frequency.
- ② Set the desired CTCSS tone frequency or DTCS code in SET MODE.
 - See p. 35 for programming details.
- ③ Push **[A•FUNC]**, then push **[1•TONE]**.
 - Repeat several times until “▷” appears when CTCSS, or “Ⓜ” appears when DTCS is selected.

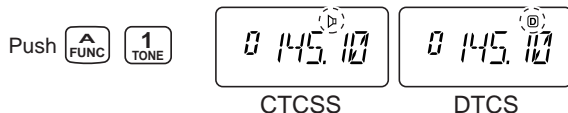

- ④ Push **[A•FUNC]**, then push **[2•P.BEEP]** to activate the pocket beep function.
 - “Ⓜ” appears.

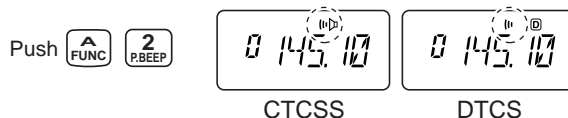

- ⑤ When a signal with the matching tone is received, the transceiver emits beep tones and blinks “Ⓜ.”
 - Beep tones sound for 30 sec. and “Ⓜ” blinks. To stop the beeps manually, push any key. “Ⓜ” continues blinking until step ⑥ is operated.

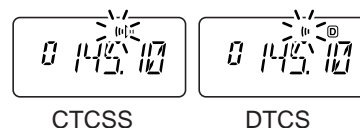

- ⑥ Push **[PTT]** to answer.
 - “Ⓜ” disappears and cancels the pocket beep function automatically.

■ Tone scan

By monitoring a signal on a repeater, or using pocket beep or tone squelch function, you can determine the tone frequency or code necessary to access a repeater or open the squelch.

- ① Set the frequency to be checked for a tone frequency or code.
- ② Push [**A•FUNC**], then push [**1•TONE**].
 - Repeat several times to select the type of tone to be scanned. (One of “♪,” “▷” or “Ⓜ” appears)
 - Tone scan may be used even if the tone condition or type is not selected.

Push  

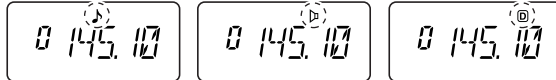

- ③ Push [**A•FUNC**], then push [**3•T.SCAN**] to start the tone scan.
 - To change the scanning direction, push [**▲**] or [**▼**].

Push  



- ④ When the CTCSS tone frequency or DTCS code is matched, the squelch opens and the tone frequency or code is temporarily programmed into the selected mode such as memory or call channel.
 - The tone scan pauses when a CTCSS tone frequency or 3-digit DTCS code is detected.
 - The decoded CTCSS tone frequency or 3-digit DTCS code is used for the tone encoder or tone encoder/decoder depending on the selected tone condition or type in step ②.
 - No indication : Cannot be used for operation.
 - “♪” : CTCSS tone encoder
 - “▷” : CTCSS tone encoder/decoder
 - “Ⓜ” : DTCS tone encoder/decoder
- ⑤ Push [**D•CLR**] to stop the scan.

■ Pager function

This function uses DTMF codes for paging and can be used as a “message pager” to confirm you of a caller’s identification even when you leave the transceiver temporarily unattended.

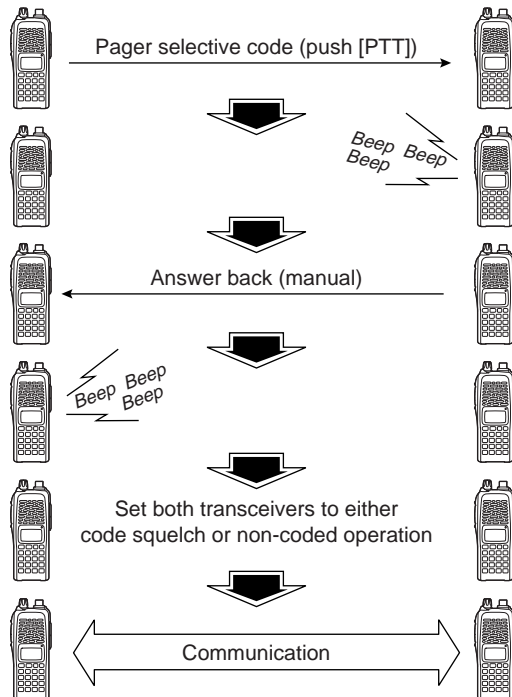

■ Code programming

◇ Before programming

The pager and code squelch functions require ID codes and a group code. These codes are 3-digit DTMF codes and must be written into the code channels before operation.

- ① Decide the ID code of each transceiver and a group code for your group.
- ② Decide whether you want to return to normal operation or code squelch operation after a connection is made.
- ③ Program the ID code, group code and transmit codes (other station’s codes) as below.

◇ Code channel assignment

ID OR GROUP CODE	CODE CHANNEL NUMBER	“RECEIVE ACCEPT” OR “RECEIVE INHIBIT”
Your ID code	0	“Receive accept” only
Other parties’ ID code	1–6	“Receive inhibit” should be programmed in each channel.
Group code	One of 1–6	“Receive accept” must be programmed in one channel.
Memory space*	P	“Receive inhibit” only.

*Channel CP automatically memorizes an ID code when receiving a pager call. The contents in channel CP cannot be changed manually.

◆ Code programming

Your ID code **MUST** be programmed into code channel C0. Up to 6 transmit codes (codes that you transmit) are programmable into code channels, C1 to C6, if required.

- ① Push [**A•FUNC**], then push [**0•OPT**] to enter OPTION SET MODE.

- Rotate [**VOL**] to select “dtm.PG” or “dtm.CS,” if “dtm.OF” appears.

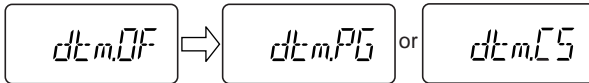

- ② Push and hold [**0•OPT**] for 1 sec. to enter the code selection mode.

- One of either “CP” or “C0” to “C6” blinks.
- “C0” is your ID code and “C1” to “C6” are transmit codes.

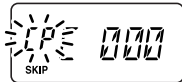

- ③ Rotate [**VOL**] (or push [**▲**]/[**▼**]) to select code channel C0.
- Each transceiver should have a different ID code.
- ④ Enter the desired 3-digit ID code via the keypad.

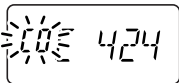

- ⑤ Rotate [**VOL**] (or push [**▲**]/[**▼**]) to select a transmit code channel from C1 to C6.

- ⑥ Enter the desired 3-digit transmit code via the keypad.

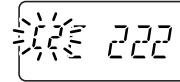

- ⑦ Push [**A•FUNC**], then push [**6•SKIP**] to set the channel to “receive inhibit” or “receive accept.”

- When “receive inhibit” is set, “SKIP” appears as below.
- Code channel C0 cannot be set as “receive inhibit.”
- See the table for “receive accept” and “receive inhibit” details (p. 38).

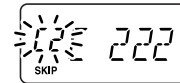

- ⑧ Repeat steps ⑤ and ⑥ to set additional transmit code channels, if desired.
- ⑨ Push [***•ENT**] or [**PTT**] to exit code selection mode.

• Receive accept/receive inhibit

- “Receive accept” (“SKIP” indicator does not appear) accepts pager calls when the transceiver receives a signal with a code the same as that in the code channel.
- “Receive inhibit” (“SKIP” indicator appears) ignores calls even when the transceiver receives a code the same as that in the code channel. Transmit codes should therefore be programmed for “receive inhibit,” otherwise the transceiver will not reject unnecessary calls.

■ Pager operation

◇ Calling a specific station

- ① Program the code channel in advance (p. 39).
- ② Set the operating frequency.
 - Set the volume and squelch to the desired level as in normal operation.
- ③ Push **[A•FUNC]**, then push **[0•OPT]**.
 - Rotate **[VOL]** to select “dtm.PG,” if “dtm.CS” or “dtm.OF” appears.

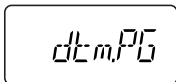

- ④ Select the desired transmit code channel:
 - ➔ Push and hold **[0•OPT]** for 1 sec. to enter the code selection mode.
 - ➔ Rotate **[VOL]** to select the desired code channel.
 - ➔ Push **[*•ENT•O]** to return to previous mode.
 - 100 MHz digit shows “P.”

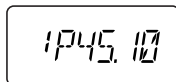

- ⑤ Push **[PTT]** to transmit the pager code.
- ⑥ Wait for an answer back.
 - When the transceiver receives an answer back code, the function display shows the other member’s ID or group code.

- ⑦ After confirming a connection, push **[A•FUNC]** and **[0•OPT]** to enter **OPTION SET MODE**, then rotate **[VOL]** to select the code squelch operation “dtm.CS,” or non-selective calling system “dtm.OF.”
 - DO NOT push any digit keys while code channels C0 to C6 are displayed, otherwise code channel contents will be changed.
- ⑧ Communicate with the other party as normal: push **[PTT]** to transmit; release to receive.

◇ Waiting for a call from a specific station

- ① Set the operating frequency.
- ② Push **[A•FUNC]**, then push **[0•OPT]**.
 - ➔ Rotate **[VOL]** to select “dtm.PG,” if “dtm.CS” or “dtm.OF” appears.
 - ➔ Push **[*•ENT•O]** to return to previous mode.
 - 100 MHz digit shows “P.”
- ③ Wait for a call.
 - When receiving a call, the caller’s ID or group code appears as shown at next page.
 - DO NOT push any digit keys while code channels C0 to C6 are displayed, otherwise code channel contents will be changed.
- ④ Push **[PTT]** to send an answer back call and display the operating frequency.
- ⑤ After confirming a connection, push **[A•FUNC]** and **[0•OPT]** to enter **OPTION SET MODE**, then rotate **[VOL]** to select the code squelch operation “dtm.CS,” or non-selective calling system “dtm.OF.”

• PERSONAL CALLS

This display appears when you are called with your ID code and the calling station's ID code is 123.

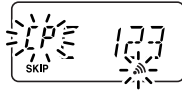

“CP” and “” blink.

• GROUP CALLS

This display appears when you are called with the group code, 888, and 888 has been programmed into code channel C6.



• ERROR INFORMATION

When the transceiver receives an incomplete code, “E” and previously received code appear.

Previously received code.

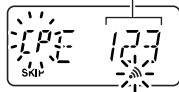

During channel number indication (described on page 16)
To use these functions in channel number indication, the pager/code squelch setting must be programmed with other memory contents before selecting channel number indication.

■ Code squelch

When using code squelch you will only receive calls from stations which know your ID or group code. A 3-digit code is sent each time [PTT] is pushed in order to open the receiving station's code squelch prior to voice transmission.

- ① Set the operating frequency.
 - Set the volume and squelch to the desired level as in normal operation.
- ② Push [A•FUNC], then push [0•OPT].
 - Rotate [VOL] to select “dtm.CS,” if “dtm.PG” or “dtm.OF” appears.
- ③ Select the desired transmit code channel:
 - Push and hold [0•OPT] for 1 sec. to enter code selection mode.
 - Rotate [VOL] to select the desired code channel.
 - Push [~~*ENT~~•O] to exit code selection mode and return to previous mode.
 - 100 MHz digit shows “C.”

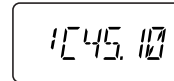

- ④ Operate the transceiver in the normal way (push [PTT] to transmit; release [PTT] to receive).
- ⑤ To cancel the code squelch, push [A•FUNC] and [0•OPT], then rotate [VOL] to select “dtm.OF.”
 - 100 MHz digit shows “1” for IC-V82 or “4” for IC-U82 when the function is cancelled.

■ Digital mode operation

The IC-V82/U82 with optional UT-118 DIGITAL UNIT can be operated for digital voice mode and low-speed data operation for both transmit and receive. It can also be connected to a GPS receiver (compatible with an RS-232 output/NMEA format/4800 bps) and transmit/receive position data.

■ Call sign programming

Four types of call sign memories are available for your own call sign “myC,” other station call sign “yUC,” nearest repeater call sign “R1C” and another zone’s repeater call sign “R2C.” Each call sign memory can store up to 6 call signs, and each call sign programmed up to 8 characters.

◆ Your own call sign programming

Your own call sign must be programmed for both digital voice and low-speed data communications (including GPS transmission).

- 1 Push **[A•FUNC]** and **[0•OPT]** to enter OPTION SET MODE, then push **[▲]** or **[▼]** several times to select the call sign select mode.
 - “myC” appears.

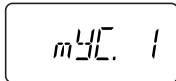

- 2 Push and hold **[0•OPT]** for 1 sec. then rotate **[VOL]** to select the desired call sign channel.



- 3 Push **[▲]** to select call sign programming mode.
 - The 1st digit blinks and channel indication stops blinking.
- 4 Rotate **[VOL]** to set the desired character or code.
 - Push **[▼]** or **[▲]** to move the cursor to left or right, respectively.
- 5 Push **[▲]** to select 2nd digit, then rotate **[VOL]** to select the desired character or code.
 - 2nd digit blinks (1st digit stops blinking).
 - Repeat this step for programming your own call sign.



- 6 Push **[0•OPT]** to save the call sign.
- 7 Rotate **[VOL]** to select an another channel from “C1” to “C6.”
- 8 Repeat steps ② to ⑦ to program your own call sign channels.

NOTE: All digital (DV) mode operation/settings require an optional UT-118 DIGITAL UNIT. A transceiver without UT-118 does not indicate any items for the digital (DV) mode described in this section.

◆ Your call sign note programming

You can add information to your own call sign such as operating radio type or area. Call sign notes are coupled with the same channel number of your own call signs, and they are transmitted or indicated after your own call signs. Call sign notes can be stored up to 6 types, and each call sign note programmed up to 4 characters.

- ① Push **[A•FUNC]** and **[0•OPT]** to enter OPTION SET MODE, then push **[▲]** or **[▼]** several times to select the call sign select mode.
 - “myS” appears.

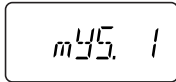

- ② Push and hold **[0•OPT]** for 1 sec. then rotate **[VOL]** to select the desired call sign note channel.

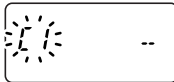

- ③ Push **[▲]** to set into call sign note programming mode.
 - The 1st digit blinks and channel indication stops blinking.
- ④ Rotate **[VOL]** to select the desired character or code.
 - Push **[▼]** or **[▲]** to move the cursor to left or right, respectively.

- ⑤ Push **[▲]** to select 2nd digit, then rotate **[VOL]** to select the desired character or code.
 - 2nd digit blinks (1st digit stops blinking).
 - Repeat this step for programming your own call sign note.



- ⑥ Push **[0•OPT]** to save the call sign.
- ⑦ Rotate **[VOL]** to select an another channel from “C1” to “C6.”
- ⑧ Repeat steps ② to ⑦ to program your call sign note channels.

11 DIGITAL MODE OPERATION

◆ Station call sign programming

Station call sign must be programmed for the specified station call as well as repeater operation in both digital voice and low-speed data communications.

- ① Push [**A•FUNC**] and [**0•OPT**] to enter OPTION SET MODE, then push [**▲**] or [**▼**] several times to select the call sign select mode.

- “yUC” appears for station call sign.

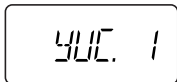

- ② Push and hold [**0•OPT**] for 1 sec. then rotate [**VOL**] to select the desired call sign channel.

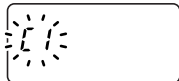

- ③ Push [**▲**] to select call sign programming mode.
 - The 1st digit blinks and channel indication stops blinking.
- ④ Rotate [**VOL**] to select the desired character or code.
 - Push [**▼**] or [**▲**] to move the cursor to left or right, respectively.

- ⑤ Push [**▲**] to select 2nd digit, then rotate [**VOL**] to select the desired character or code.
 - 2nd digit blinks (1st digit stops blinking).
 - Repeat this step for programming station call sign.

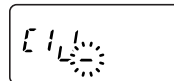

- ⑥ Push [**0•OPT**] to save the call sign.
- ⑦ Rotate [**VOL**] to select an another channel from “C1” to “C6.”
- ⑧ Repeat steps ② to ⑦ to program another station call sign channels.

✓ For your information:

Station and/or repeater call sign can be programmed from Received call record when a call is received.
See page 46 for details.

■ Digital voice mode operation

- ① Set the desired frequency in VFO mode. (pgs. 13, 14)
 - Select output power, if desired. (p. 15)
- ② Push [**A•FUNC**] then [**0•OPT**] to enter OPTION SET MODE, then push [**▲**] or [**▼**] several times to select the digital select mode.
 - “DG” appears.
- ③ Rotate [**VOL**] to turn the digital mode ON.

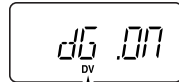
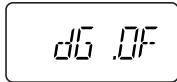

↑
Appears

- ④ Push [**▲**] once to select the your own call sign select mode.
 - “myC” appears.
- ⑤ Push and hold [**0•OPT**] for 1 sec. then rotate [**VOL**] to select the desired your own call sign channel, if you have programmed several call signs.
 - After selecting the your own call sign, push [**0•OPT**] to return to OPTION SET MODE.

NOTE: In the digital mode operation; when “BUSY” indicator appears but no sound comes out the speaker, it may be caused by the interference of analog FM mode. In this case, to prevent interference of analog FM mode, set the digital monitor setting (p. 49) to “An (analog)” then listen on the channel before transmitting by pushing [**MONI**].

◇ When sending a CQ

(continued from step ⑤)

- ⑥ Select “CQ” as the station call sign.
 - Push [**▲**] or [**▼**] several times to select the call sign select mode.
 - “yUC” appears.
 - Push and hold [**0•OPT**] for 1 sec. then rotate [**VOL**] to select the desired channel.
 - Push and hold [**0•OPT**] for 1 sec. to set “CqCqCq.”



- Push [***•ENT•O**] (or [**D•CLR**]) to exit OPTION SET MODE.

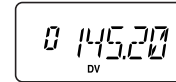

- ⑦ Push and hold [**PTT**] to transmit and speak into the microphone at normal voice level.
 - Transmit indicator appears and the RF meter shows the output power.
- ⑧ Release [**PTT**] to return to receive.
 - The other station call sign will be received.
 - Received call signs can be stored into the received call record automatically. See page 46 for details.

11 DIGITAL MODE OPERATION

◆ When calling the desired station

(continued from p. 45 step ⑤)

- ⑥ Select the desired station call sign.
- Push **[▲]** or **[▼]** several times to select the call sign select mode.
 - “yUC” appears.
 - Push **[0•opt]** then rotate **[VOL]** to select the desired call sign (pre-programmed), or set the desired call sign. (see p. 44)

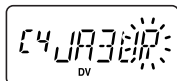

- Push **[*•ENT•>]** to exit OPTION SET MODE.

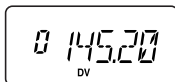

- ⑦ Push and hold **[PTT]** to transmit and speak into the microphone at normal voice level.
- Transmit indicator appears and the RF meter shows the output power.
- ⑧ Release **[PTT]** to return to receive.
- The other station call sign will be received.
 - Received call signs can be stored into the received call record automatically (see next set of instructions).

■ When receiving a digital call

When an individual station call is received, the calling station call sign can be stored into the received call record. The record is cleared once the transceiver is turned OFF.

◆ Received call record

- ① Push **[A•FUNC]** then **[0•OPT]** to enter OPTION SET MODE, then push **[▲]** or **[▼]** several times to select the received call indication.
- “RXC.AL,” “RSC.AL,” “R1C.AL,” and “R2C.AL” are available for the received station call sign, station call sign note, repeater 1 and repeater 2 call signs, respectively.

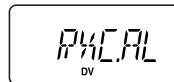

- ② To confirm the received call, push and hold **[0•OPT]** for 1 sec. to enter the received call sign indication mode.

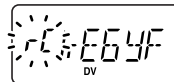

◆ To store a received call

- ① Push [**A•FUNC**] and [**0•OPT**] to enter OPTION SET MODE, then push [**▲**] or [**▼**] several times to select the call sign select mode.
 - “yUC” appears for station call sign.
 - “R1C” or “R2C” appears for repeater call sign.



- ② Push and hold [**0•OPT**] for 1 sec. to display call sign, rotate [**VOL**] to select the blank channel or erasable channel.

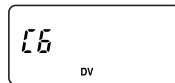

- ③ Push [**0•OPT**] then, push [**▲**] or [**▼**] several times to select the received call indication.
 - “RXC.AL” appears for received station call sign.
 - “R1C.AL” or “R2C.AL” appears for received repeater call sign.
- ④ To confirm the received call, push and hold [**0•OPT**] for 1 sec. to enter the received call sign indication mode.

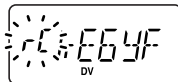

- ⑤ Push and hold [**0•OPT**] for 1 sec. to store the call sign into the selected (in step ②) station call sign channel or repeater call sign channel.

■ Break-in communication

The break-in function allows you to break into another station's communications in both digital voice and low-speed data operation.

- ① While receiving another station's communication, push [**A•FUNC**] then [**0•OPT**] to enter OPTION SET MODE.
- ② Push [**▲**] or [**▼**] several times to select the break-in setting, then turn the break-in setting ON.
 - “bRk” appears.

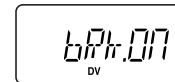
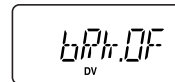

- ③ When both stations are in standby, transmit to send a break-in call.
 - Programmed call sign station receives the break-in call as well as your own call sign.
- ④ Wait for the reply call from the station who receives the break-in call.
- ⑤ After you receive a reply, communicate normally.
- ⑥ To cancel the break-in, push [**A•FUNC**] and [**0•OPT**], then rotate [**VOL**] to turn OFF.

11 DIGITAL MODE OPERATION

■ EMR communication

The EMR communication mode is available for digital mode operation. In the EMR communication mode, no call sign setting is necessary. When an EMR communication mode signal is received, the audio (voice) will be sound in the specified level ("12' level) even the volume setting is set to any level.

- ① Set the desired frequency then push **[A•FUNC]** and **[0•OPT]** to enter OPTION SET MODE.
- ② Push **[▲]** or **[▼]** several times to select the EMR setting, then rotate **[VOL]** to turn the EMR setting ON.
 - "EmR" appears.

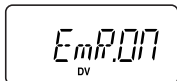
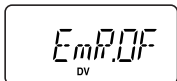

- ③ Push **[*•ENT•>•]** (or **[D•CLR]**) to exit OPTION SET MODE, then operate the transceiver normal way.
- ④ To cancel the EMR communication mode, push **[A•FUNC]** and **[0•OPT]**, then rotate **[VOL]** to turn OFF.

■ Pocket beep operation

This function uses a digital code/call sign for calling and can be used as a "common pager" to inform you that someone has called while you were away from the transceiver. The digital code or call sign squelch does not function while in a low-speed data communication.

◇ Waiting for a call from a specific station

- ① Set the operating frequency.
- ② Program the digital code or call sign.
 - See p. 53, "Digital code setting" or p. 42 "Call sign programming."
- ③ Push **[A•FUNC]** and **[1•TONE]** one or more times until "ⓐ" or "▷" appears in the function display.
 - "ⓐ" for call sign squelch; "▷" for digital code squelch operation.
- ④ Push **[A•FUNC]**, then push **[2•P.BEEP]** to activate the pocket beep function.
 - "Ⓜ" appears.
- ⑤ When a signal with the matched call sign/digital code is received, the transceiver emits beep tones and blinks "Ⓜ."
 - Beep tones sound for 30 sec. and "Ⓜ" blinks. To stop the beeps manually, push any key. "Ⓜ" continues blinking until step ⑥ is operated.
- ⑥ Push **[PTT]** to answer.
 - "Ⓜ" disappears and cancels the pocket beep function automatically.
- ⑦ To cancel the call sign/digital code squelch, push **[A•FUNC]** and **[1•TONE]** one or more times until "ⓐ" or "▷" disappears.

■ Digital squelch functions

The digital code (CSQL) or call sign (DSQL) squelch opens only when receiving a voice signal with the same pre-programmed digital code or call sign, respectively. The digital code or call sign squelch does not function while in a low-speed data communication.

- ① Set the operating frequency.
- ② Program the digital code or call sign.
 - See p. 53, “Digital code setting” or p. 42 “Call sign programming.”
- ③ Push [**1•TONE**] one or more times until “**Ⓞ**” or “**▷**” appears in the function display.
 - “**Ⓞ**” for call sign squelch; “**▷**” for digital code squelch operation.
- ④ When a signal with the matched call sign/digital code is received, the squelch opens and the signal can be heard.
 - When the received signal includes an unmatched call sign/digital code, the squelch does not open. However, the S-meter shows the received signal strength.
 - To open the squelch manually, push and hold [**MONI**].
- ⑤ Operate the transceiver in the normal way (push [**PTT**] to transmit; release [**PTT**] to receive).
- ⑥ To cancel the call sign/digital code squelch, push [**1•TONE**] one or more times until or “**Ⓞ**” or “**▷**” disappears.

■ Digital monitor USING INITIAL SET MODE

This function is used to listen to the analog signal (FM mode signal) without changing the operating mode during digital (DV mode) operation.

- ① While pushing and holding [**▲**] and [**▼**], turn the power ON to enter INITIAL SET MODE.
- ② Push [**▲**] or [**▼**] several times until “dmO” appears.
- ③ Rotate [**VOL**] to turn the digital monitor setting to “An” or “dG.”
 - “An”: Activate for monitoring the analog (FM mode) signals. (default)
 - “dG”: Activate to open the call sign or digital code squelch.



- ④ Push [***•ENT•◀**] (or [**D•CLR**]) to exit INITIAL SET MODE.

NOTE: When “digital monitor setting” is set to “An (analog),” the monitor function (pushing [**MONI**]) works as the analog monitor for receiving an FM signal. Then digital monitor function is activated using the Squelch control (pushing [**MONI**] and [**▲**] or [**▼**]).

✓ While scanning in digital mode:

- The call sign squelch function deactivate, then after cancelling the scan it will activate again.
- Scan stops near channel in a 5 kHz tuning steps, and then no sound comes out.

11 DIGITAL MODE OPERATION

■ Low-speed data communication

In addition to the digital voice communication, a low-speed data communication is available (Refer p. 4 about the transceiver-PC connection details).

- ① Set the desired frequency.
- ② Verify and set repeater call, transmit output power and other conditions.
- ③ Push [**A•FUNC**] then [**0•OPT**] to enter OPTION SET MODE, then push [**▲**] or [**▼**] several times to select the automatic data transmission setting. (see p. 53)
 - “AtX” appears.
 - Skip this setting, if you want to transmit manually.

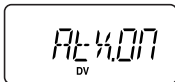
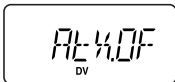

- ④ Push [**▲**] once to select the data communication speed setting. (see p. 54)
 - “SPd” appears.
 - Select suitable data speed for your PC or application.

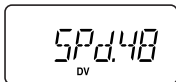

4800 bps

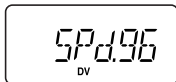

9600 bps

- ⑤ Start up the low-speed data communication application.
- ⑥ Set the application as follows.
 - Port : The same COM port number as transceiver's
 - Baud rate : 4800 bps or 9600 bps (same as step ④)
 - Data : 8 bit
 - Parity : None
 - Stop : 1 bit
 - Flow control: Xon/Xoff
- ⑦ Transceiver automatically transmits or receives the data while the computer is sending data to transceiver. Or push and hold [**PTT**] to transmit, release to receive the data manually.
 - Refer to the instructions of the application that how to send or receive data.

■ About D-STAR system

In the D-STAR system, repeater linking via a 10 GHz band backbone and internet network (gateway connection) capabilities are available. This system provides you with much wider coverage range during digital voice mode operation.

• D-STAR system outline (440 MHz band)

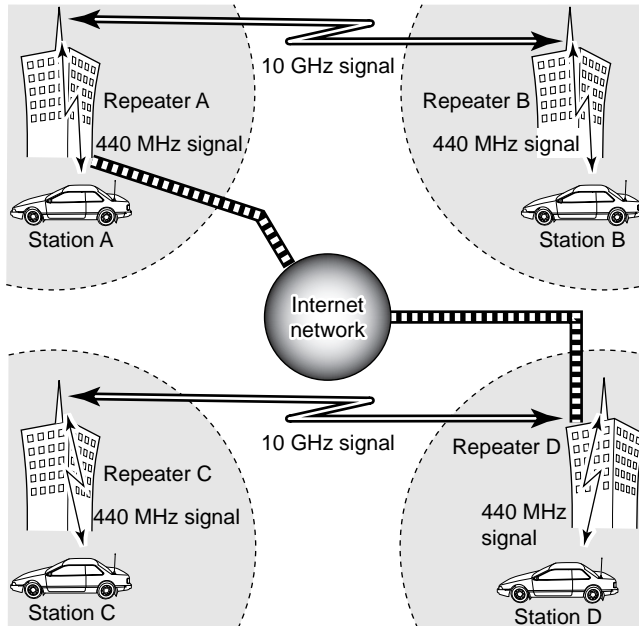

For current existing repeater operation, stations that are communicating must be in the same repeater's operating area. However, in the D-STAR system as in the illustration at left, the repeaters can be linked via the system repeaters (with a 10 GHz signal). Thus stations A and B can communicate even though they are in different repeater operating areas.

Also, the D-STAR system repeaters are connectable through the internet network— gateway connection capability.

For example, when station B uses the gateway connection station B can communicate with the station C! By using the gateway connection, long distance communications like DX operation may be possible with 144 MHz (for IC-V82)/ 440MHz (for IC-U82) digital voice!

In the D-STAR system, an independent repeater's operating area is called an Area and a group that links repeaters via a 10 GHz backbone is called a Zone.

NOTE: The digital repeater for either 144 MHz or 440 MHz of amateur radio bands operation is not available at present of November 2004. It will be designed in the future.

11 DIGITAL MODE OPERATION

■ Repeater call sign programming

Repeater call sign must be programmed for repeater operation in both digital voice and low speed data communications.

- ① Push **[A•FUNC]** and **[0•OPT]** to enter OPTION SET MODE, then push **[▲]** or **[▼]** several times to select the call sign items.
 - “R1C” or “R2C” appears for repeater call sign.

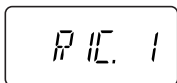

- ② Push and hold **[0•OPT]** for 1 sec. then rotate **[VOL]** to select the desired call sign channel.

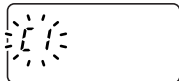

- ③ Push **[▲]** to select call sign programming mode.
 - The 1st digit blinks and channel indication stops blinking.
- ④ Rotate **[VOL]** to set the desired character or code.
 - Push **[▼]** or **[▲]** to move the cursor to left or right, respectively.
- ⑤ Push **[▲]** to select 2nd digit, then rotate **[VOL]** to set the desired character or code.
 - 2nd digit blinks (1st digit stop blinking).
 - Repeat this step for programming repeater call sign.



- ⑥ Push **[0•OPT]** to save the call sign.
- ⑦ Rotate **[VOL]** to select an another channel from “C1” to “C6.”
- ⑧ Repeat steps ② to ⑦ to program other repeater call sign channels.

✓ For your information:

Station and/or repeater call sign can be programmed from Received call record when a call is received.
See page 46 for details.

✓ For your information:

Repeater call sign can be programmed for gateway connection capabilities at step ④ for connecting to the another Area or Zone.

- “G” appears or disappears as the 8th digit when pushing **[8•SET]**.

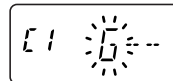

While using the repeater 2 (other Area or Zone) system, the repeater 2 setting must be selected ON in OPTION SET MODE.

- “R2C” (Repeater 2 call sign) can be programmed or used when “RP2” (Repeater 2 setting) is set to ON (default).

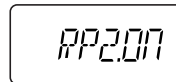

■ Setting other items

- ① Push [**A•FUNC**] and [**0•OPT**] to enter OPTION SET MODE, then push [**▲**] or [**▼**] several times to select the desired item.
- ② Rotate [**VOL**] to select the desired value or condition.
 - To exit SET MODE, push [***•ENT→○**] (or [**D•CLR**]).

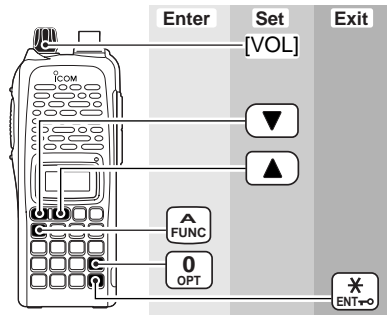

◇ Auto Reply

During digital mode operation, auto reply function is available. This function replies to an individual station call even you are away from the transceiver. (default: OFF)

After the manual transmission (pushing [**PTT**]) or message transmission, the Auto Reply setting returns to OFF automatically.

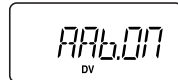
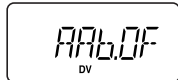

◇ Digital Code

Sets the desired digital code for digital code squelch operation. Total of 100 codes (00–99) are available. (default: 00)



◇ Auto data Transmission

During low-speed data operation, auto data transmission function is available. This function transmits when data has been input from PC via the [**DATA**] jack. (default: OFF)

After the manual transmission (pushing [**PTT**]), the Auto Transmission setting returns to OFF automatically.

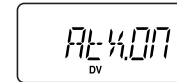
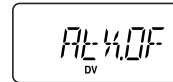

11 DIGITAL MODE OPERATION

◆ Data Speed

Select the communication speed between the transceiver and PC from 4800 bps or 9600 bps. (default: 9600 bps)

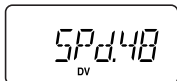

4800 bps

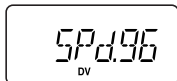

9600 bps

◆ Standby Beep

Changes the beep emission capability when the communicating station finishes transmitting or the receive signal disappears. (default: OFF)

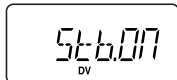
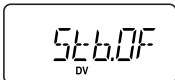

◆ Auto Rx call sign Write

When an individual station call is received, the calling station call sign can be stored automatically. The stored call sign can be re-called when selecting a station call sign. (default: OFF)

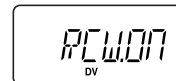
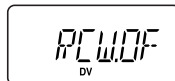

◆ Auto Rx repeater call sign Write

When an individual station call via the repeater is received, the repeater call sign can be stored automatically. The stored repeater's call sign can be re-called when selecting a repeater call sign. (default: OFF)

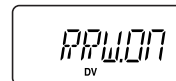

◆ Auto Rx call sign Display

When an individual station call is received, the calling station call sign can be indicated automatically. (default: ON)

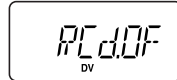
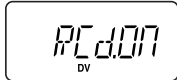

◆ Auto your own call sign Display

Sets auto your own call sign display function ON and OFF. When this setting is set to ON, the transceiver automatically indicates your programmed call sign at turning power ON or digital mode transmission. (default: OFF)

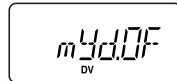
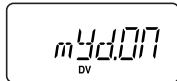

◆ Message Transmission

Select the Message transmission function ON and OFF. When ON is selected, transceiver transmits a text message (pre-programmed). (default: OFF)

After one transmission, the Message Transmission setting returns to OFF automatically.

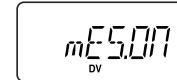
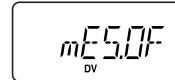

◆ Tx message

Tx messages are available up to 6 channels and each channel can be programmed with a message of up to 20 characters. Available characters are 0 to 9, A to Z (capital letters only), some symbols and space. (see the next page for details)

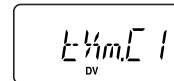

11 DIGITAL MODE OPERATION

◆ Tx message programming

At least one of the Tx message channels must be programmed, if you want to use the GPS message. The GPS message is transmitted from Tx message channels.

- ① While in OPTION SET MODE, push **[▲]** or **[▼]** several times to select “tXm,” then push and hold **[0•OPT]** for 1 sec. to edit the message indication, and then rotate **[VOL]** to select the message channel.
 - One of either “C1” to “C6” blinks.
- ② Push **[▲]** to select message programming mode.
 - The 1st digit blinks and channel indication stops blinking.
- ③ Rotate **[VOL]** to set the desired character.
- ④ Push **[▲]** to select 2nd digit, then rotate **[VOL]** to select the desired character.
 - 2nd digit blinks (1st digit stop blinking).
 - Repeat this step for programming.
- ⑤ Push **[0•OPT]** to save the message.
- ⑥ Repeat steps ② to ⑤ to set another message channels.
- ⑦ Push **[*•ENT•O]** (or **[D•CLR]**) to exit OPTION SET MODE.

• Available characters

(space)	! (!)	' (')	# (#)	\$ (\$)	% (%)	& (&)	' (')	((l)) (r)	* (*)	+ (+)	, (,)
-- (-)	. (.)	/ (/)	0 (0)	1 (1)	2 (2)	3 (3)	4 (4)	5 (5)	6 (6)	7 (7)	8 (8)	9 (9)
! (:)	! (:)	' (<)	-- (=)	' (>)	' (?)	@ (@)	A (A)	B (B)	C (C)	D (D)	E (E)	F (F)
G (G)	H (H)	I (I)	J (J)	K (K)	L (L)	M (M)	N (N)	O (O)	P (P)	Q (Q)	R (R)	S (S)
T (T)	U (U)	V (V)	W (W)	X (X)	Y (Y)	Z (Z)	[(l)	^ (l)	_ (l)	^ (r)		

◆ Rx message indication

When an individual station call with message is received, the message can be stored into the Rx message record, up to 6 records and each record can indicate a message of up to 20 characters. The oldest record is overwritten when another message is received.

- ① While in OPTION SET MODE, push **[▲]** or **[▼]** several times until “RXm” appears.

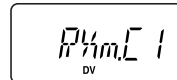

- ② Push and hold **[0•OPT]** for 1 sec. to edit the message indication, and then rotate **[VOL]** to select the message recorded.
 - One of either “C1” to “C6” blinks.

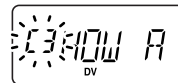

- ③ Push **[▲]** (or **[▼]**) to scroll the message.
 - Push **[▼]** or **[▲]** to move the cursor to left or right, respectively.

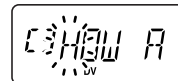

- ④ Push **[*•ENT•O]** (or **[D•CLR]**) to exit OPTION SET MODE.

■ GPS operation

A GPS receiver (RS-232 output/NMEA format/4800 bps) can be connected to [DATA] jack of the IC-V82/U82 to indicate the current position (Latitude and Longitude). The position data can also be transmitted with a message to another station.

◇ Position indication

- ① While connected to a GPS receiver, push [A•FUNC] and [0•OPT] to enter OPTION SET MODE.
- ② Push [▲] or [▼] several times to select the GPS setting.
 - “GPS” appears.



- ③ Rotate [VOL] to select the suitable sentence formatter for the connecting GPS receiver.

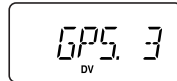

• Sentence formatters

1	GLL	6	GLL, GGA	11	GGA, GSA	16	GLL, GGA, RMC	21	GLL, GSA, VTG
2	GGA	7	GLL, RMC	12	GGA, VTG	17	GLL, GGA, GSA	22	GGA, RMC, GSA
3	RMC	8	GLL, GSA	13	RMC, GSA	18	GLL, GGA, VTG	23	GGA, RMC, VTG
4	GSA	9	GLL, VTG	14	RMC, VTG	19	GLL, RMC, GSA	24	GGA, GSA, VTG
5	VTG	10	GGA, RMC	15	GSA, VTG	20	GLL, RMC, VTG	25	RMC, GSA, VTG

- ④ Push [▲] twice to select the position indication.



- ⑤ Push and hold [0•OPT] for 1 sec. to enter the position indication.
 - Latitude and longitude date appear in order as below.

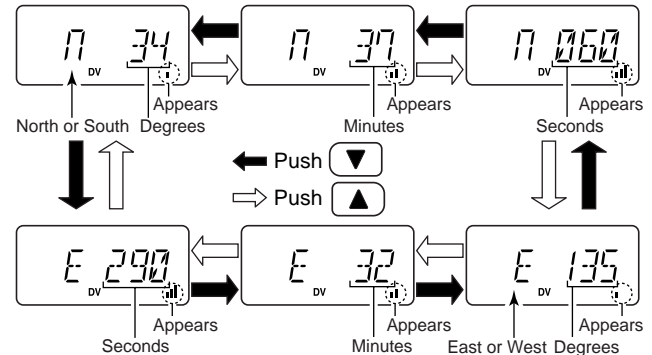

- ⑥ After checking the current position, push [*•ENT↔] (or [D•CLR]) to return to normal operating mode.

IMPORTANT: When setting the sentence formatter in step ③ for connection to a GPS receiver, and you have already programmed your own call sign, the GPS transmit setting will automatically activate to every 3 minutes. The automatic transmission can be changed to an interval time or deactivated, if desired. (see the next page)

11 DIGITAL MODE OPERATION

◆ GPS Automatic transmission

- ① While connected to a GPS receiver, push [**A•FUNC**] and [**0•OPT**] to enter OPTION SET MODE.
- ② Push [**▲**] or [**▼**] several times to select the GPS automatic transmission.
 - “GtX” appears.

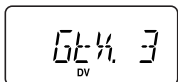

- ③ Rotate [**VOL**] to set the interval time for the GPS automatic transmission.
 - Interval time is selectable from 0.5 (30 sec.), 1, 3, 5, 10, 30 min.

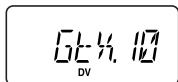

- ④ Push [**▲**] three times to select the transmit message selection, if desired.
 - GPS Tx message is selectable from OFF and C1 to C6.
 - Tx message must be programmed in advance. (see page 56 for setting)

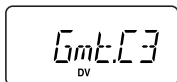
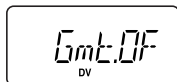

- ⑤ Push [***•ENT**] (or [**D•CLR**]) to exit OPTION SET MODE.

/// **IMPORTANT:** GPS Automatic transmission transmits at every setting interval even while receiving another stations communication. To prevent interference to other stations, set the the Repeater lockout item “RLO” (set to “bU” busy lockout) in INITIAL SET MODE. (p. 64)

◆ Receiving a GPS transmission

- ① Push [**A•FUNC**] and [**0•OPT**] to enter OPTION SET MODE.
- ② Push [**▲**] or [**▼**] several times to select the received position.
 - “RXP.OS” appears.

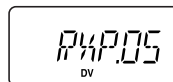

- ③ Push and hold [**0•OPT**] for 1 sec. to enter the position indication.
 - Latitude data and longitude data appear by every pushing [**▲**] or [**▼**].
- ④ Push [**0•OPT**] to return OPTION SET MODE, then push [**▲**] twice to select the received GPS message.
- ⑤ Push and hold [**0•OPT**] for 1 sec. to enter the message.
 - Received message is indicated, push [**▼**] or [**▲**] to move the cursor to left or right, respectively.
- ⑥ After checking a received position or message, push [***•ENT**] (or [**D•CLR**]) to return to normal operating mode.

■ SET MODE

◇ Entering SET MODE

- ① Push [**A•FUNC**], then push [**8•SET**] to enter SET MODE.
- ② Push [**▲**] or [**▼**] to select the desired item.
- ③ Rotate [**VOL**] to select the condition/value.
 - To exit SET MODE, push [***•ENT↔O**] (or [**D•CLR**]).

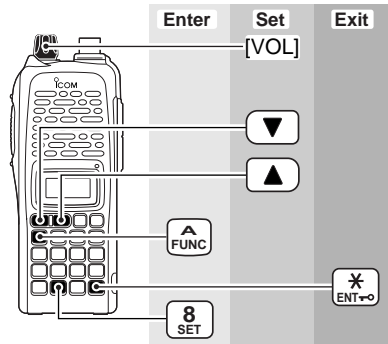

NOTE: When the display type setting (pgs. 16, 65) in INITIAL SET MODE is selected other than “FR” (“CH” or “nm”) and accessing SET MODE from memory mode, most of set mode items are restricted.

◇ Repeater tone frequency

Selects tone encoder frequency for accessing a repeater, etc. from one of 50 available frequencies.

- 67.0–254.1 Hz (50 tones): 88.5 Hz (default)

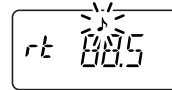

◇ Tone squelch frequency

Selects frequency for tone squelch or pocket beep operation from one of 50 available frequencies.

- 67.0–254.1 Hz (50 tones): 88.5 Hz (default)

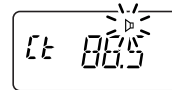

• Available subaudible tone frequencies

67.0	79.7	94.8	110.9	131.8	156.7	171.3	186.2	203.5	229.1
69.3	82.5	97.4	114.8	136.5	159.8	173.8	189.9	206.5	233.6
71.9	85.4	100.0	118.8	141.3	162.2	177.3	192.8	210.7	241.8
74.4	88.5	103.5	123.0	146.2	165.5	179.9	196.6	218.1	250.3
77.0	91.5	107.2	127.3	151.4	167.9	183.5	199.5	225.7	254.1

12 OTHER FUNCTIONS

◇ DTCS code

Selects DTCS (both encoder/decoder code) for DTCS squelch operation. Total of 104 codes are available.

- 023–754: 023 (default)

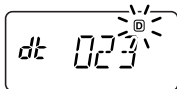

◇ DTCS polarity

Selects DTCS polarities for transmission and reception from “nn (default),” “nR,” “Rn” and “RR.” (n: normal/R: reverse)

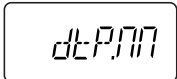

◇ Tuning step

Selects tuning step from 5, 10, 12.5, 15, 20, 25, 30 and 50 kHz for [▲]/[▼] or [VOL] (When [VOL] is assigned as tuning dial) operation. (default value may differ depending on transceiver types and versions)

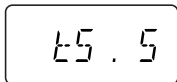

◇ Offset frequency

Sets the duplex offset frequency within 0 to 20 MHz range. During duplex (repeater) operation, transmit frequency (or receive when reverse function is set to ON) shifts the set frequency. (default value may differ depending on transceiver types and versions)

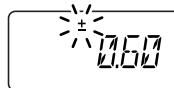

◇ Reverse function

Turns the reverse function ON and OFF (default).

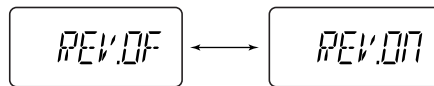

Reverse function OFF

Reverse function ON

◇ Scan pause timer

Selects the scan pause time from SCt.5, SCt.10, SCt.15 and SCP. 2. When receiving signals, the scan pauses according to the scan pause time.

- SCt. 5/10/15: Scan pauses for 5/10/15 sec. (default: SCt.15)
- SCP. 2 : Scan pauses until the signal disappears. Resumes 2 sec. after the signal disappears.



◇ Function key timer

Selects the function indicator display timer (when pushed [A•FUNC]) from F0.At, F1.At, F2.At, F3.At and F.m.

- F0.At : "F" disappears immediately after secondary function is operated. (default)
- F1/2/3.At: "F" disappears after 1/2/3 sec. after secondary function is operated.
- F.m : "F" appears until [A•FUNC] is pushed again.

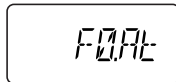
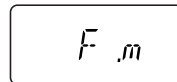
◇ LCD backlight

Selects LCD backlight lighting condition from auto, ON and OFF.

- LIG.At : Lights when any key except [PTT] is pushed. (default)
- LIG.ON : Lights continuously while the transceiver is powered ON.
- LIG.OF : Never lights.

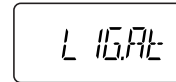

◇ Transmission permission

Turns transmission permission ON and OFF. This function can be set for each memory and call channel, independently.

- tX.On : Transmission is permitted. (default)
- tX.OF : Transmission is inhibited.

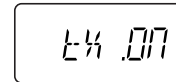

12 OTHER FUNCTIONS

◆ Memory bank setting

Sets the desired memory bank (A to J and OFF) to assign the regular memory channels.

This item appears when SET MODE is accessed from memory mode only.

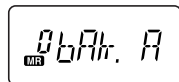
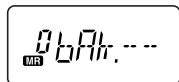

◆ Memory bank link function

Sets the memory bank link function ON and OFF (default). The link function provides continuous banks scan, scanning all contents in the selected banks during bank scan.

This item appears when SET MODE is accessed from memory mode only.

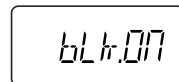
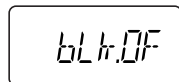

• Bank link setting

- ① Rotate [VOL] to select the memory bank link function ON.
- ② Push [▲] or [▼] to select the desired bank to be linked.
 - bLA: Bank A, bLb: Bank B, bLC: Bank C, bLd: Bank D, bLE: Bank E, bLF: Bank F, bLG: Bank G, bLH: Bank H, bLI: Bank I, bLJ: Bank J
- ③ Rotate [VOL] to "ON" to link the bank.
- ④ Repeat steps ② and ③ to link other banks.

◆ Wide/Narrow setting

Selects both the transmission and reception passband width from wide (default) and narrow.

When narrow is selected, the transmission and reception passband width become half of the wide setting (approx.).

This setting can be set for each memory, call and VFO independently.

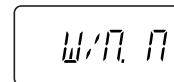
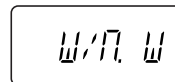

◆ Weather alert function

IC-V82 [USA]/[CSA] versions only

Turns weather alert function ON and OFF (default).

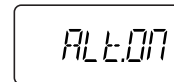
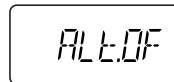

■ INITIAL SET MODE AT POWER ON

The INITIAL SET MODE is accessed at power on and allows you to set seldom-changed settings. In this way, you can “customize” transceiver operations to suit your preference and operating style.

◇ Entering INITIAL SET MODE

- ① While pushing and holding [▲] and [▼], turn power ON.
- ② Push [▲] or [▼] to select the desired item.
- ③ Rotate [VOL] to select the condition or value.
 - To exit INITIAL SET MODE, push [*ENT↔] (or [D•CLR]).

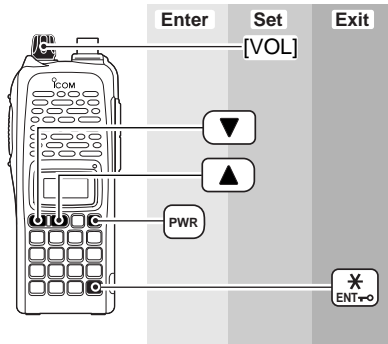

◇ Key-touch beep

Turns key-touch beep emission ON (Beep level 1 to 3) or OFF.
(default: 3)

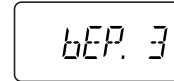

NOTE: The pocket beep level (Beep level 1 to 3 or OFF) also changes as this setting.

◇ Time-out timer

To prevent accidental prolonged transmission, etc., the transceiver has a time-out timer. This function cuts a transmission OFF after 1–30 min. of continuous transmission. This timer can be cancelled.

- tOt.OF : The time-out timer is turned OFF. (default)
- tOt. 1–30: The transmission is cut OFF after the set period elapses.

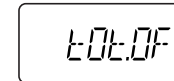

12 OTHER FUNCTIONS

◆ Auto repeater

USA/CSA versions only

The auto repeater function automatically turns ON or OFF the duplex operation and tone encoder. The offset and repeater tone is not changed by the auto repeater function. Reset these frequencies, if necessary.

- RPt.OF : The auto repeater function is turned OFF.
- RPt.R1 : Activates for duplex only. (default)
- RPt.R2 : Activates for duplex and tone.

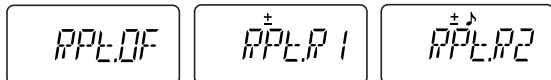

◆ Auto power-off

The transceiver can be set to automatically turn OFF after a specified period with a beep when no key operations are performed.

- 30 min., 1 hour, 2 hours and OFF (default) can be specified. The specified period is retained even when the transceiver is turned OFF by the auto power-off function. To cancel the function, select "POF.OF" in this SET MODE.



NOTE: While an optional UT-118 DIGITAL UNIT is installed and GPS automatic transmit function is activated, this function does not work.

◆ Repeater lock-out

Selects lockout type from repeater, busy and OFF.

- RLO.OF : No lockout is activated. (default)
- RLO.RP : The repeater lockout is turned ON.
- RLO.bU : The busy lockout is turned ON.

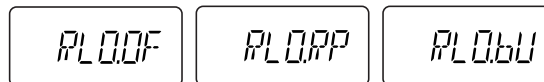

◆ Squelch delay

Selects squelch delay from short and long to prevent repeated opening and closing of the squelch during reception of the same signal.

- Sqt. S : The squelch closes in short delay. (default)
- Sqt. L : The squelch closes in long delay.



◇ DTMF rate

The rate at which DTMF memories send individual DTMF characters can be set to accommodate operating needs.

- 1: 100 msec. interval; 5.0 cps rate (default)
- 2: 200 msec. interval; 2.5 cps rate
- 3: 300 msec. interval; 1.6 cps rate
- 5: 500 msec. interval; 1.0 cps rate (cps=characters/sec.)

A rectangular LCD display showing the text "dtd. 1" in a monospaced font.

◇ Dial assignment

Selects [VOL] control action from volume and tuning dial.

- tOP.VO: AF volume (default)
- tOP.dl : Tuning dial

A rectangular LCD display showing the text "tOP.VO" in a monospaced font.

A rectangular LCD display showing the text "tOP.dl" in a monospaced font.

◇ Display type

Selects LCD indication type from frequency, channel number and channel names.

- dSP.FR : Shows frequency (default)
- dSP.CH : Shows channel number*
- dSP.nm : Shows channel names†

*Only memory channels can be selected.

†Frequency indication will be displayed when the selected memory channel has no programmed memory name.

A rectangular LCD display showing the text "dSP.FR" in a monospaced font.

A rectangular LCD display showing the text "dSP.CH" in a monospaced font.

A rectangular LCD display showing the text "dSP.nm" in a monospaced font.

/// **NOTE:** When this setting is selected other than "FR" ("CH" or "nm") and accessing SET MODE from memory mode, most of set mode items are restricted.

◇ LCD contrast

Selects LCD contrast from auto, high and low.

- LCd.At : Automatic (default)
- LCd.HI : High contrast
- LCd.LO : Low contrast

A rectangular LCD display showing the text "LCd.At" in a monospaced font.

A rectangular LCD display showing the text "LCd.HI" in a monospaced font.

A rectangular LCD display showing the text "LCd.LO" in a monospaced font.

12 OTHER FUNCTIONS

◇ Power save

Selects duty cycle for power save function from auto, 1:32, 1:16, 1:8, 1:2 and OFF.

- P-S.At : Duty cycle changes automatically. (default)
- P-S.32 : 1:32 duty cycle
- P-S.16 : 1:16 duty cycle
- P-S. 8 : 1:8 duty cycle
- P-S. 2 : 1:2 duty cycle
- P-S.OF : The power save function is turned OFF.

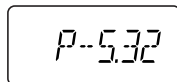
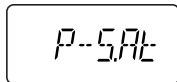

NOTE: While DV mode operation (with UT-118), or pager/code squelch operation (with UT-108), the active duty cycle is fixed 1:1 only (even for duty cycle settings other than OFF).

◇ Monitor key action

The monitor key, **[MONI]**, can be set as a 'sticky' key. When set to the sticky condition, each push of **[MONI]** toggles the monitor function ON and OFF.

- PU (Push) : Pushing and holding **[MONI]** to monitor the frequency. (default)
- HO (Hold) : Push **[MONI]** to monitor the frequency and push again to cancel it.

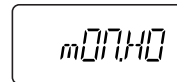
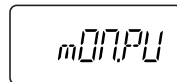

◇ Digital monitor setting

Set the desired monitoring mode during digital mode operation from "An (Analog)" and "dG (Digital)."

This item appears only when an optional UT-118 DIGITAL UNIT is installed.

- An (Analog) : Activate for monitoring the analog (FM mode) signals. (default)
- dG (Digital) : Activate to open the call sign or digital code squelch.



◇ Tuning speed acceleration

The tuning speed acceleration automatically speeds up the tuning speed when pushing and holding **[▲]** or **[▼]**, or rotating **[VOL]** rapidly.*

- S-S.At : The tuning speed acceleration is activated. (default)
- S-S.m : The tuning speed acceleration is not activated.

*When tuning dial is assigned with **[VOL]**.

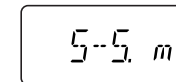
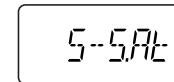

◇ Mic simple mode

Optional HM-75A required

This item turns the microphone simple mode ON and OFF. Microphone simple mode is used to change the function assignments for keys in the optional HM-75A REMOTE CONTROL SPEAKER-MICROPHONE as below. This assignment is convenient for 3-channel use of simple operation.

- mIC.n1 : Normal 1 (default)
- mIC.n2 : Normal 2
- mIC.Sm: Simple mode

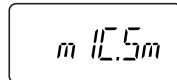
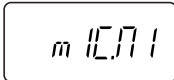

HM-75A key	Mode	NORMAL1	NORMAL2	SIMPLE
[A]	Freq. CH	[B•CALL] Null	[MONI]	[MONI]
[B]	Freq. CH	VFO/Memory Null	VFO/Memory Null	[B•CALL]
[▲]	Freq. CH	Freq. Up Memory CH Up	Freq. Up Memory CH Up	MR-00CH
[▼]	Freq. CH	Freq. Down Memory CH Down	Freq. Down Memory CH Down	MR-01CH

A 1750 Hz tone can be transmitted with the HM-75A operation.

➡ Push [A] while pushing [PTT].

NOTE:

Turn power OFF when connecting the HM-75A to the transceiver.

VFO mode cannot be selected via the microphone when SIMPLE mode is selected.

12 OTHER FUNCTIONS

◇ S-meter squelch

Sets S-meter squelch threshold level from OFF (default) and S1–S3.

This setting allows you to set a minimum signal level needs to open the squelch.

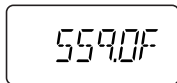

S59.0F

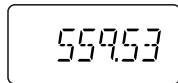

S59.53

◇ ALC function

Sets the ALC (automatic Level Control) function ON and OFF (default).

The ALC function reduces the microphone gain automatically when the transmission audio is distorted.

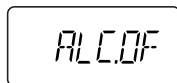

ALC.OF

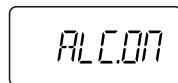

ALC.ON

◇ Battery protection function

Sets the Battery protection function from LI (Li-Ion) and OFF (default).

LI(Li-Ion):

➔ The transceiver does not memorized the transceiver ON/OFF condition when battery is detached, and automatically returns to OFF condition even if you detach the battery with the transceiver ON condition. You are required to turn ON the transceiver by pushing **[PWR]** for every battery attach.

➔ Beep sounds when the attached battery is exhaustion.

- The battery must be charged presently.

OFF : The transceiver memorizes the transceiver ON/OFF condition when battery is detached.

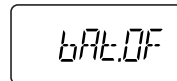

bAL.OF

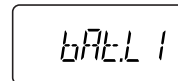

bAL.LI

/// **NOTE:** This item **MUST** be set “LI” (Li-Ion) when the attaching battery is BP-211N (Li-Ion).

■ Weather channel operation (IC-V82 [USA] version only)

◇ Weather channel selection

- ① Push [**C•MR**] several times to select weather channel group.

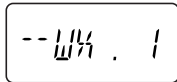

Weather channel group indication

- ② Push [**▲**] or [**▼**] several times to select the desired weather channel.
 ③ Push [**C•MR**] to select memory mode, or push [**D•CLR**] to select VFO mode.

◇ Weather alert function

An NOAA broadcast station transmits weather alert tone before important weather announcements. When the weather alert function is turned ON, the selected weather channel is monitored each 5 sec. for the announcement. When the alert signal is detected, the “ALT” and the WX channel are displayed alternately and sounds a beep tone until the transceiver is operated. The previously selected (used) weather channel is checked periodically during standby or while scanning.

- ① Select the desired weather channel.
 ② Turn the weather alert function ON in SET MODE.
 ➔ Push [**A•FUNC**] and [**8•SET**] to enter SET MODE.
 ➔ Push [**▲**] or [**▼**] to select the weather alert item, then rotate [**VOL**] to set ON.
 ➔ push [***ENT•O**] (or [**D•CLR**]) to exit SET MODE.
 ③ Sets the desired stand-by condition.
 • Selects VFO, memory or call channel.
 • Scan or priority watch operation can also be selected.
 ④ When the alert is detected, a beep sounds and the following indication will be displayed.

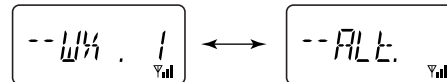

Shows above indications alternately.

- ⑤ Turn the weather alert function OFF in SET MODE.

NOTE: While receiving a signal (on a frequency other than the weather alert ON frequency), the receiving signal or audio will be interrupted momentarily every 5 sec. (approx.) in case the alert function is turned ON. This symptom is caused by the WX alert function. To cancel these symptoms, set the weather alert item OFF in SET MODE.

12 OTHER FUNCTIONS

■ CPU reset

AT POWER ON

The function display may occasionally display erroneous information (e.g. when first applying power). This may be caused externally by static electricity or by other factors.

If this problem occurs, turn power OFF. After waiting a few seconds, turn power ON again. If the problem persists, perform the following procedure.

• Partial resetting is also available. See right for details.

/// IMPORTANT!:

Resetting the transceiver **CLEARs** all memory information and initializes all values in the transceiver.

➔ While pushing **[MONI]** and **[D•CLR]**, push and hold **[PWR]** for 1 sec. to reset the CPU.

• "CLEAR" indicates, then initial display appears.

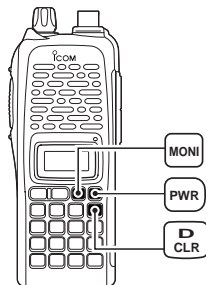

■ Partial reset

AT POWER ON

If you want to initialize the operating conditions (VFO frequency, VFO settings, set mode contents) without clearing the memory contents, a partial resetting function is available for the transceiver.

➔ While pushing **[D•CLR]**, push and hold **[PWR]** for 1 sec. to partially reset.

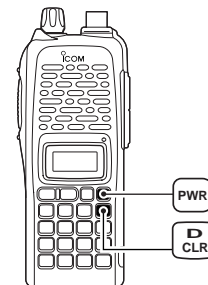

Cloning allows you to quickly and easily transfer the programmed contents from one transceiver to another transceiver.

■ Transceiver-to-transceiver cloning

- ① Connect the OPC-474 CLONING CABLE to the [SP] jack of the master and sub-transceivers.
 - The master transceiver is used to send data to the sub-transceiver.

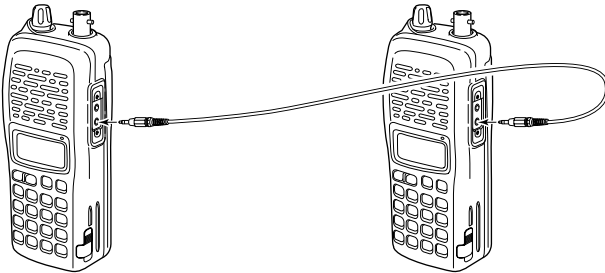

AT POWER ON

- ② While pushing [A•FUNC] and [▲], turn power ON to enter cloning mode (master transceiver only—power ON for sub-transceiver).
 - “CLONE” appears and the transceivers enter the clone standby condition.

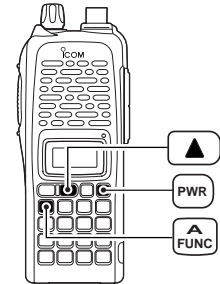
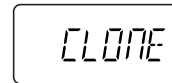

- ③ Push [PTT] on the master transceiver.
 - “CL OU” appears in the master transceiver’s display and S-meter indicator shows that data is being transferred to the sub-transceiver.
 - “CL IN” appears automatically in the sub-transceiver’s display and S-meter indicator shows that data is being received from the master transceiver.
- ④ When cloning is finished, turn power OFF, then ON again to exit cloning mode.

NOTE: DO NOT push [PTT] on the sub-transceiver during cloning. This will cause a cloning error.

13 CLONING

■ Cloning using a PC

Please refer to the HELP file that comes with CS-V82
CLONING SOFTWARE.

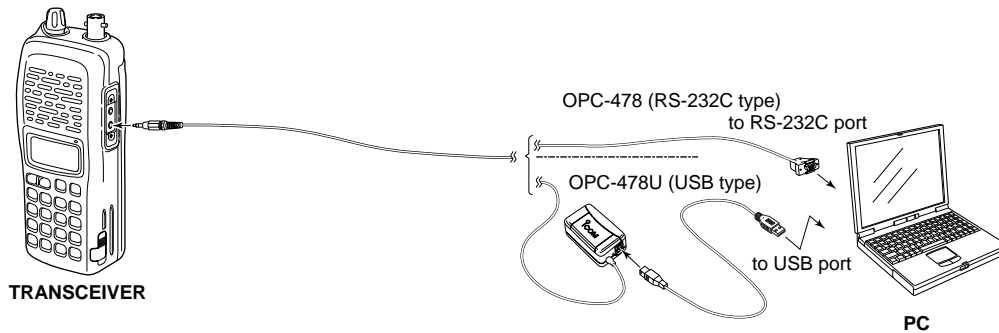

■ Optional UT-108/118 installation

- ① Remove the optional connector access cover.
 - Unscrew two screws and remove the optional connector cover.

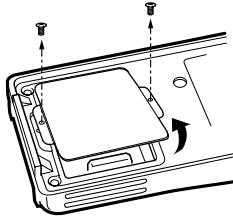

- ② Attach the optional unit. Insert the connector firmly to avoid a bad contact.
 - Remove the paper baking of the optional unit before installing.
- ③ Replace the optional connector cover and two screws.
- ④ Program the necessary information from the transceivers keypad or using the cloning software, before operation.

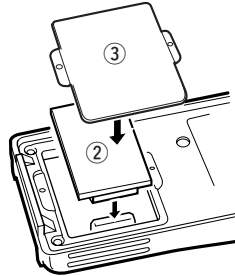

■ Optional MB-86 installation

◇ MB-86 stopper

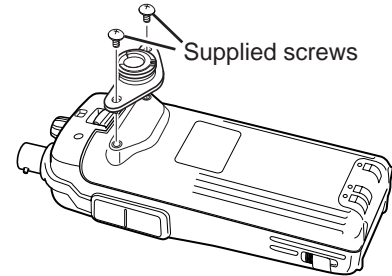

◇ MB-86 belt clip

When clipping to a part of your belt

When releasing

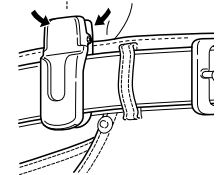
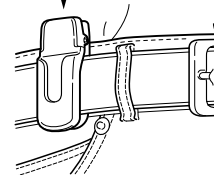
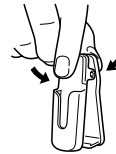

14 OPTIONAL UNITS

◇ MB-86 stopper

• When attaching

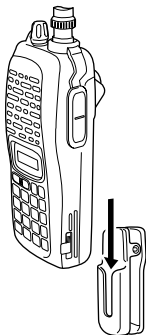

• When removing

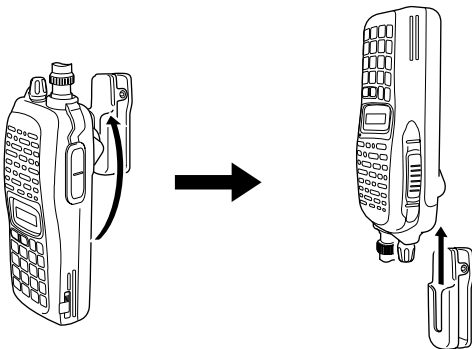

CAUTION!
HOLD THE TRANSCEIVER TIGHTLY, WHEN ATTACHING OR REMOVING THE TRANSCEIVER FROM THE BELT CLIP.

If the transceiver is accidentally dropped and the swivel belt clip's stopper is cracked or damaged, the swivel belt clip may not work properly.

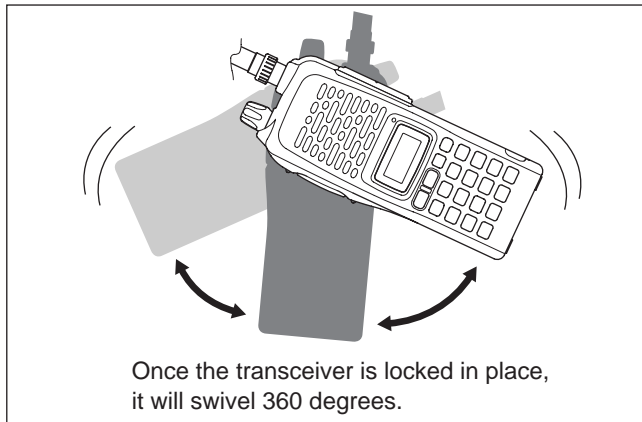

■ IC-V82

GENERAL

- Frequency coverage : (unit: MHz)
 - USA Tx: 144–148/Rx: 136–174*
 - Europe, Taiwan, Korea Tx/Rx: 144–146
 - General (LM), CSA (LM) Tx/Rx: 136–174*
- *Guaranteed: 144–148 MHz range only.
- Type of emission : FM
- Number of memory channels : 207 (incl. 6 scan edges and 1 call)
- Frequency resolution : 5, 10, 12.5, 15, 20, 25, 30, 50 kHz
- Operating temperature range : –10°C to +60°C; +14°F to +140°F
- Frequency stability : ±2.5 ppm (–10°C to +60°C)
- Power supply requirement : 7.2 V DC (6–10.3 V DC acceptable; Icom's battery pack only)
- Current drain (at 7.2 V DC: approx.):
 - Transmit
 - at 7 W (High) 2.6 A
 - at 4 W (Middle) 2.0 A
 - at 0.5 W (Low) 1.0 A
 - Receive
 - standby 80 mA
 - power save 30 mA
 - max. audio 250 mA
- Antenna connector : BNC (50 Ω)
- Dimensions (proj. not included) : 54(W) × 139(H) × 36.7(D) mm
2¹/₈(W) × 5¹/₂(H) × 1⁷/₁₆(D) in
- Weight (approx.) : 390 g; 13.8 oz
(with BP-222N and Ant.)
200 g; 7.1 oz
(without battery pack and Ant.)
- Ext. data connector : 3-conductor 2.5 (d) mm (1/10")

TRANSMITTER

- Modulation system : Variable reactance frequency mod.
- Output power (at 7.2 V) : 7 W/4 W/0.5 W (High/Mid/Low)
- Max. frequency deviation : ±5.0 kHz [Wide]/±2.5 kHz [Narrow]
- Spurious emissions : Less than –60 dBc
- Microphone connector : 3-conductor 2.5 (d) mm (1/10")/2.2 kΩ

RECEIVER

- Receive system : Double-conversion superheterodyne
- Intermediate frequencies : 1st: 46.35 MHz, 2nd: 450 kHz
- Sensitivity (at 12 dB SINAD) : 0.16 μV typical
- Squelch sensitivity (threshold) : 0.11 μV typical
- Selectivity :
 - [Wide] More than 55 dB
 - [Narrow] More than 50 dB
- Spurious and image rejection : 80 dB typical
- Intermodulation : 65 dB typical
- Audio output power : More than 0.3 W at 10% distortion with
(at 7.2 V DC) an 8 Ω load
- Ext. speaker connector : 3-conductor 3.5 (d) mm (1/8")/8 Ω

All stated specifications are subject to change without notice or obligation.

15 SPECIFICATIONS

■ IC-U82

GENERAL

- Frequency coverage : (unit: MHz)
 - USA Tx: 420–450*/Rx: 400–479*1
 - Europe, Korea Tx/Rx: 430–440
 - General (LM), China (LM) Tx/Rx: 400–479*2

*1Guaranteed: 440–450 MHz range only.
*2Guaranteed: 430–440 MHz range only.
- Type of emission : FM
- Number of memory channels : 207 (incl. 6 scan edges and 1 call)
- Frequency resolution : 5, 10, 12.5, 15, 20, 25, 30, 50 kHz
- Operating temperature range : –10°C to +60°C; +14°F to +140°F
- Frequency stability : ±2.5 ppm (–10°C to +60°C)
- Power supply requirement : 7.2 V DC (6–10.3 V DC acceptable; Icom's battery pack only)
- Current drain (at 7.2 V DC: approx.):
 - Transmit
 - at 5 W (High) 2.0 A
 - at 2 W (Middle) 1.4 A
 - at 0.5 W (Low) 0.9 A
 - Receive
 - standby 80 mA
 - power save 30 mA
 - max. audio 250 mA
- Antenna connector : BNC (50 Ω)
- Dimensions (proj. not included) : 54(W) × 139(H) × 36.7(D) mm
2¹/₈(W) × 5¹⁵/₃₂(H) × 1⁷/₁₆(D) in
- Weight (approx.) : 390 g; 13.8 oz
(with BP-222N and Ant.)
200 g; 7.1 oz
(without battery pack and Ant.)
- Ext. data connector : 3-conductor 2.5 (d) mm (1/10")

TRANSMITTER

- Modulation system : Variable reactance frequency mod.
- Output power (at 7.2 V) : 5 W/2 W/0.5 W (High/Mid/Low)
- Max. frequency deviation : ±5.0 kHz [Wide]/±2.5 kHz [Narrow]
- Spurious emissions : Less than –60 dBc
- Microphone connector : 3-conductor 2.5 (d) mm (1/10")/2.2 kΩ

RECEIVER

- Receive system : Double-conversion superheterodyne
- Intermediate frequencies : 1st: 46.35 MHz, 2nd: 450 kHz
- Sensitivity (at 12 dB SINAD) : 0.16 μV typical
- Squelch sensitivity (threshold) : 0.11 μV typical
- Selectivity :
 - [Wide] More than 55 dB
 - [Narrow] More than 50 dB
- Spurious and image rejection : 70 dB typical
- Intermodulation : 65 dB typical
- Audio output power : More than 0.3 W at 10% distortion with
(at 7.2 V DC) an 8 Ω load
- Ext. speaker connector : 3-conductor 3.5 (d) mm (1/8")/8 Ω

All stated specifications are subject to change without notice or obligation.

◇ BATTERY PACKS

Battery pack	Voltage	Capacity	Battery life*1	
			IC-V82	IC-U82
BP-208N	Battery case for AA (LR6)×6 alkaline		— *2	
BP-209N	7.2 V	1100 mAh	3 hrs. 20 min.	3 hrs. 40 min.
BP-210N	7.2 V	1650 mAh	6 hrs.	7 hrs.
BP-211N	7.4 V	1800 mAh	6 hrs. 10 min.	8 hrs. 15 min.
BP-222N	7.2 V	600 mAh	2 hrs. 15 min.	2 hrs. 50 min.

*1 Operating periods are calculated under the following conditions:

Tx:Rx:standby=1:1:8, power save function: auto setting, is activated

*2 Operating period depends on the alkaline cells used.

◇ CHARGER

- **BC-144N** DESKTOP CHARGER + **BC-145** AC ADAPTER
For rapid charging of battery packs. An AC adapter is supplied with the charger. Charging time: 1.5 to 2 hrs.
- **BC-146** BATTERY CHARGER + **BC-147** AC ADAPTER
For regular charging of battery packs. An AC adapter is additionally required. Charging time: 6.5 to 18.5 hrs.
- **BC-119N** DESKTOP CHARGER + **AD-101** CHARGER ADAPTER
For rapid charging of battery packs. An AC adapter is supplied with the charger. Charging time: 1.5 to 2 hrs.
- **BC-121N** MULTI-CHARGER + **AD-101** CHARGER ADAPTER (6 pcs.)
For rapid charging of up to 6 battery packs (six AD-101's are required) simultaneously. An AC adapter may be supplied depending on version. Charging time: 1.5 to 2 hrs.

◇ BELT CLIP

- **MB-103/MB-86** BELT CLIPS
MB-103: Same as that supplied with the transceiver.
MB-86: Swivel belt clip
- **MB-96F/MB-96N** LEATHER BELT HANGER
MB-96F: Fixed type belt hanger for use with MB-103.
MB-96N: Swivel belt hanger. MB-86's base clip is required.

◇ INTERNAL UNIT

- **UT-108** DTMF DECODER UNIT
Provides pager and code squelch capabilities.
- **UT-118** DIGITAL UNIT
Provides digital mode operation capabilities.

◇ OTHER OPTIONS

- **HM-75A/HM-131L** SPEAKER-MICROPHONES
Combination speaker-microphones that provide convenient operation while hanging the transceiver from your belt.
HM-75A has 4 function switches for remote control capabilities.
HM-131L has moisture proof construction.
- **HM-128L** EARPHONE-MICROPHONE
You can clip the microphone with PTT switch to your lapel or breast pocket.
- **HS-85** HEADSET
Allows you hands-free operation. Includes VOX, PTT and "one-touch" PTT with time-out timer.

16 OPTIONS

- **VS-1L** PTT/VOX UNIT+**HS-94/HS-95/HS-97** HEADSET
VS-1L PTT/VOX UNIT
Required when using these headsets.
HS-94 EAR-PIECE TYPE HEADSET
Earhook headset with flexible boom microphone.
HS-95 NECK-ARM TYPE HEADSET
Behind-the-head headset with flexible boom microphone.
HS-97 THROAT MICROPHONE
Throat microphone fits around your neck and picks up speech vibration.
- **CS-V82** CLONING SOFTWARE+**OPC-478/U** CLONING CABLE
Provide quick and easy programming of memory channel, memory name etc.
- **OPC-474** CLONING CABLE
For cloning between transceivers.
- **SP-13** EARPHONE
Provides clear receive audio in noisy environments.
- **FA-B2E** WHIP ANTENNA (for IC-V82)
Same as that supplied with IC-V82.
- **FA-B70C** WHIP ANTENNA (for IC-U82)
Same as that supplied with IC-U82.

Some options may not be available in some countries. Please ask your dealer for details.

MODE ARRANGEMENT 17

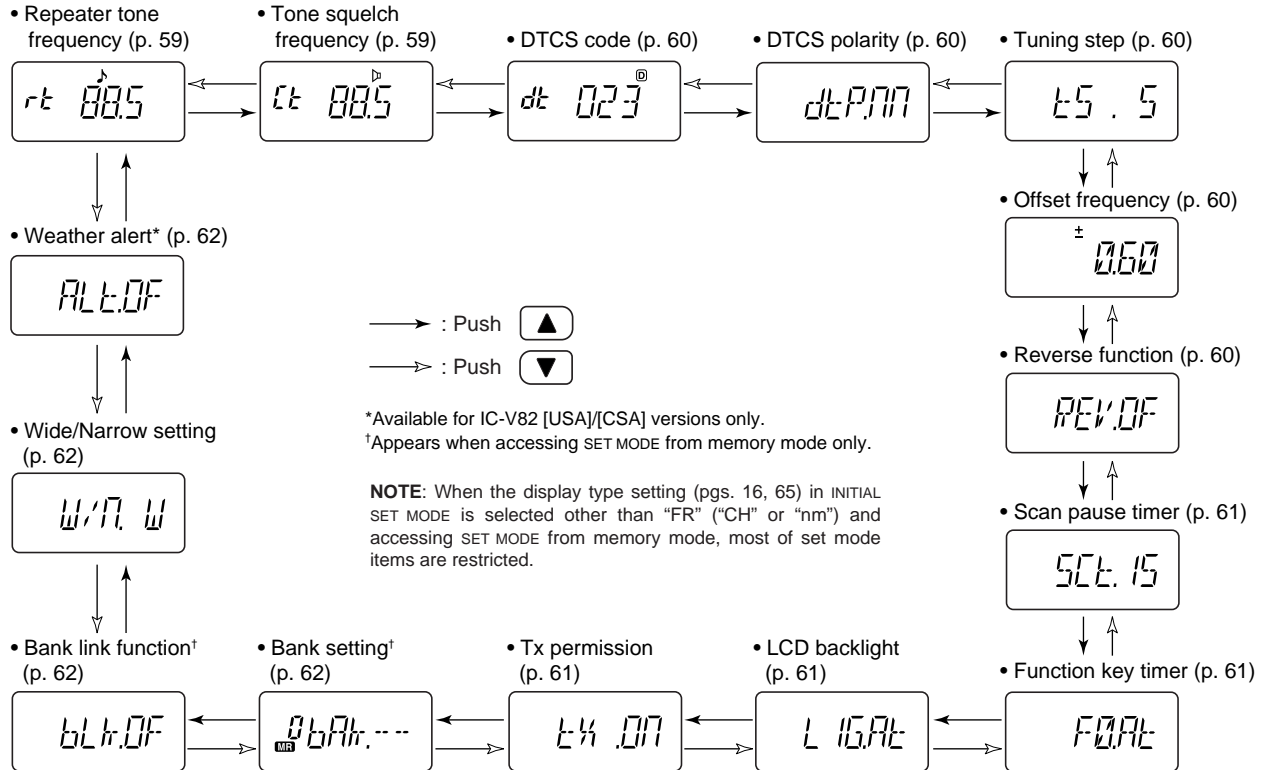

Push **▲** **FUNC**, then push **8** **SET** to enter SET MODE (p. 59).

SET MODE



17 MODE ARRANGEMENT

INITIAL SET MODE

While pushing and holding  , push  to enter INITIAL SET MODE (p. 63).

- Key touch beep (p. 63)
- Time-out timer (p. 63)
- Auto repeater* (p. 64)
- Auto power-off (p. 64)
- Repeater lock-out (p. 64)

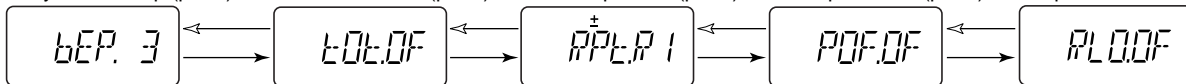

- Battery protection function (p. 68)

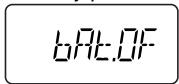

- ALC function (p. 68)

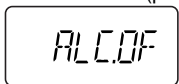

- S-meter squelch (p. 68)

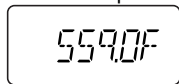

- Mic simple mode (p. 67)

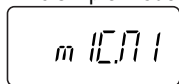

- Tuning speed acceleration (p. 66)

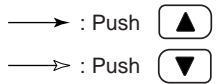
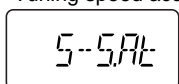

*Available for [USA]/[CSA] versions only.
 †Appears only when an optional UT-118 DIGITAL UNIT is installed.

- Digital monitor setting† (p. 66)

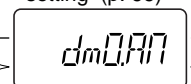

- Monitor key action (p. 66)

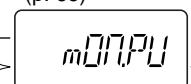

- Power save (p. 66)

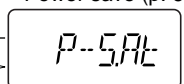

- LCD contrast (p. 65)

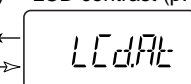

- Squelch delay (p. 64)

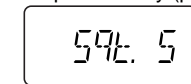

- DTMF rate (p. 65)

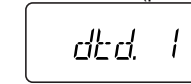

- Dial assignment (p. 65)

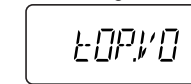

- Display type (p. 65)

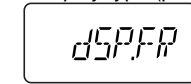

Push **▲** **FUNC**, then push **0** **OPT** to enter OPTION SET MODE (p. 53).

OPTION SET MODE

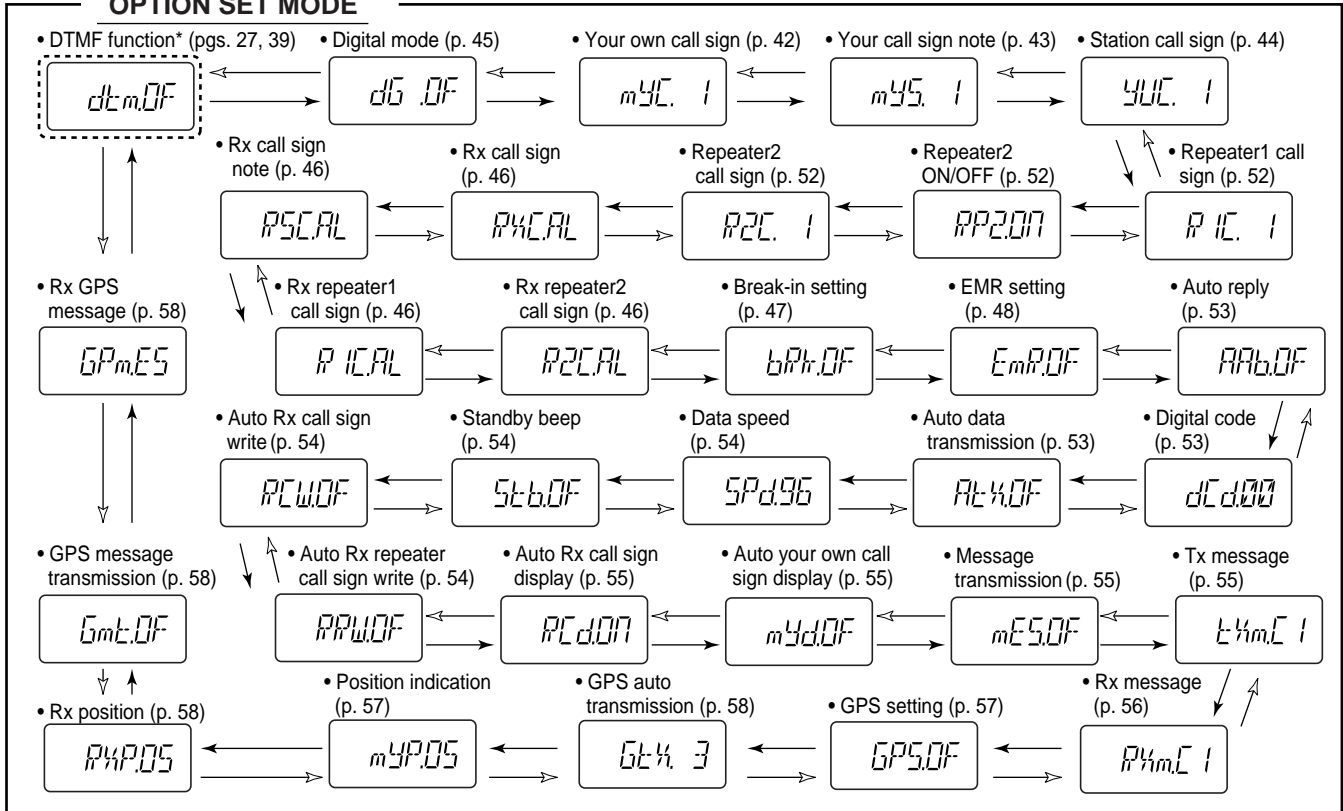

→ : Push **▲** → : Push **▼**

(dashed box) Only this item appears when no optional unit is installed, the other items appear when an optional UT-118 DIGITAL UNIT is installed.

**PG* or *CS* are selectable only when an optional UT-108 DTMF DECODER UNIT is installed.



We Icom Inc. Japan
 1-1-32, Kamiminami, Hirano-ku
 Osaka 547-0003, Japan

Declare on our sole responsibility that this equipment complies with the essential requirements of the Radio and Telecommunications Terminal Equipment Directive, 1999/5/EC, and that any applicable Essential Test Suite measurements have been performed.

Kind of equipment: FM TRANSCEIVER

Type-designation: IC-V82

Version (where applicable): _____

This compliance is based on conformity with the following harmonised standards, specifications or documents:

- i) EN 301 489-1 v 1.3.1 (2001-09)
- ii) EN 301 489-15 v 1.1.1 (2000-09)
- iii) EN 301 783 v 1.1.1 (2000-09)
- iv) EN 60950 (1992-08) + A11:1997

DECLARATION OF CONFORMITY



Düsseldorf 12th Nov. 2004
 Place and date of issue

Icom (Europe) GmbH
 Himmelgeister straÙe 100
 D-40225 Düsseldorf

Authorized representative name
 H. Ikegami
 General Manager

Signature

Icom Inc.



We Icom Inc. Japan

1-1-32, Kamiminami, Hirano-ku
Osaka 547-0003, Japan

Declare on our sole responsibility that this equipment complies with the essential requirements of the Radio and Telecommunications Terminal Equipment Directive, 1999/5/EC, and that any applicable Essential Test Suite measurements have been performed.

Kind of equipment: FM TRANSCEIVER

Type-designation: IC-U82

Version (where applicable): _____

This compliance is based on conformity with the following harmonised standards, specifications or documents:

i) EN 301 489-1 v 1.3.1 (2001-09)

ii) EN 301 489-15 v 1.1.1 (2000-09)

iii) EN 301 783 v 1.1.1 (2000-09)

iv) EN 60950 (1992-08) + A11:1997

DECLARATION OF CONFORMITY



Düsseldorf 12th Nov. 2004
Place and date of issue

Icom (Europe) GmbH
Himmelgeister straÙe 100
D-40225 Düsseldorf

Authorized representative name
H. Ikegami
General Manager

Signature

Icom Inc.

Count on us!

IC-V82

<Intended Country of Use>

#02 Europe	<input checked="" type="checkbox"/> GER	<input checked="" type="checkbox"/> FRA	<input checked="" type="checkbox"/> ESP	<input checked="" type="checkbox"/> SWE
#12 Europe-1	<input checked="" type="checkbox"/> AUT	<input checked="" type="checkbox"/> NED	<input checked="" type="checkbox"/> POR	<input checked="" type="checkbox"/> DEN
#22 Europe-2	<input checked="" type="checkbox"/> GBR	<input checked="" type="checkbox"/> BEL	<input checked="" type="checkbox"/> ITA	<input checked="" type="checkbox"/> FIN
#42 Europe-3	<input checked="" type="checkbox"/> IRL	<input checked="" type="checkbox"/> LUX	<input type="checkbox"/> GRE	<input type="checkbox"/> SUI
	<input type="checkbox"/> NOR			

IC-U82

<Intended Country of Use>

#02 Europe	<input checked="" type="checkbox"/> GER	<input checked="" type="checkbox"/> FRA	<input checked="" type="checkbox"/> ESP	<input checked="" type="checkbox"/> SWE
#12 Europe-1	<input checked="" type="checkbox"/> AUT	<input checked="" type="checkbox"/> NED	<input checked="" type="checkbox"/> POR	<input checked="" type="checkbox"/> DEN
#22 Europe-2	<input checked="" type="checkbox"/> GBR	<input checked="" type="checkbox"/> BEL	<input checked="" type="checkbox"/> ITA	<input checked="" type="checkbox"/> FIN
#42 Europe-3	<input checked="" type="checkbox"/> IRL	<input checked="" type="checkbox"/> LUX	<input type="checkbox"/> GRE	<input type="checkbox"/> SUI
	<input type="checkbox"/> NOR			